

MSCC series modular solenoid operated two way check valves can use solenoid valve to make some oil ports flow through two way.



Technical specification

Model	MSCC-02	MSCC-03
Max. flow rate (l/min)	20	75
Internal leakage (ml/min)	≤ 0.25	
Working pressure (MPa)	21	25
Weight(kg s)	A, B	1.4
	W	1.7
		3.4

Symbol list

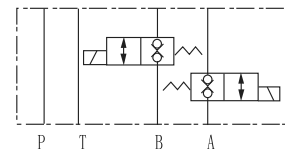

MSCC-W

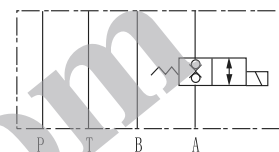

MSCC-A

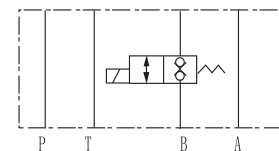

MSCC-B

Ordering details

MSCC	02	A	A230	20
Sort	Nominal size	Pilot oil port	Input voltage	Design code
Modular solenoid operated two way check valve	02:NG6 Cetop3 03:NG10 Cetop5	A:A port B:B port W:A&B port	D12:DC12 D24:DC24 A115:AC115 A230:AC230	20

Dimensions

Unit: mm

MSCC-02W

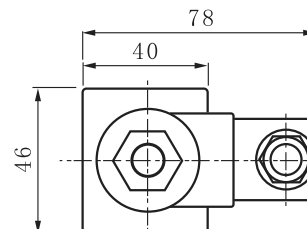
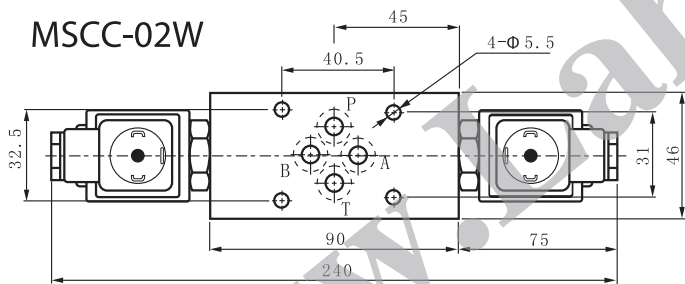

MSCC-02A

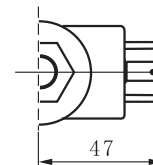
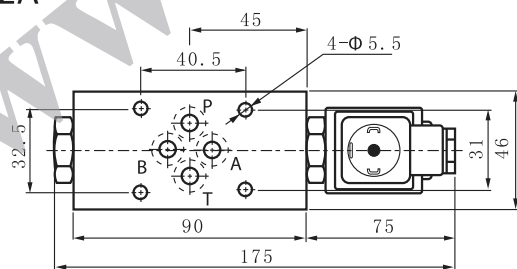

MSCC-02B

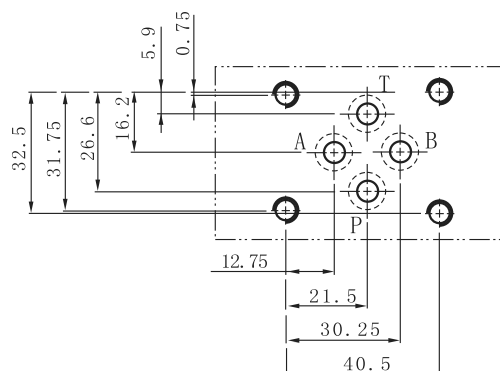
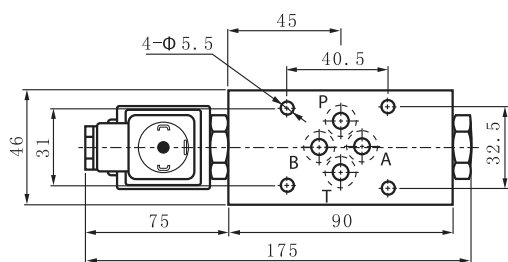

Dimensions

Unit: mm

MSCC-03W

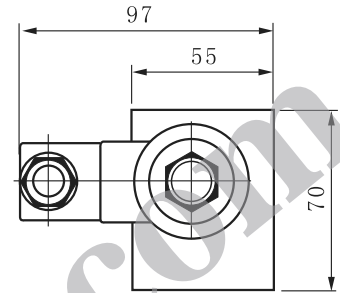
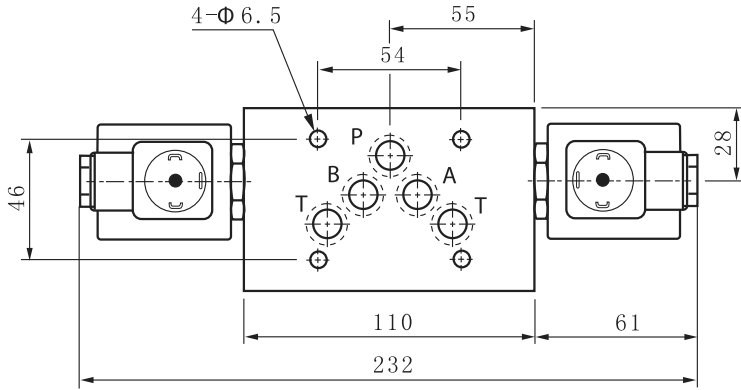

MSCC-03A

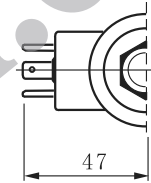
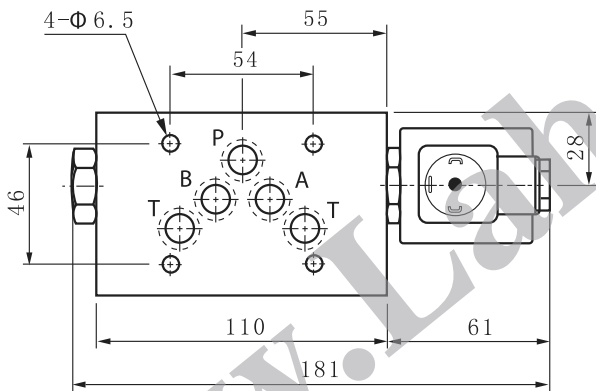

MSCC-03B

