

MBRV series modular reducing valves are used to reduce the pressure in a certain circuit lower than of the main circuit.

**Ordering details**



MBRV	02	P	K	1	20
Sort	Nominal size	Pilot oil port	Adjustment type	Pressure adjustment range	Design code
Modular relief valve	02:NG6 Cetop3 03:NG10 Cetop5 04:NG16 Cetop7 06:NG22 Cetop8	P:P port A:A port B:B port	No code: Without knob K: With plastic kob	1:8~70bar 2:35~140bar 3:70~250bar	20

**Technical specification**

Model	MBRV-02	MBRV-03	MBRV-04	MBRV-06
Max. flow rate (l/min)	35	70	300	450
Working pressure (MPa)	25			
Weight(kgs)	1.2	3.3	7.5	11.6



**Symbol list**

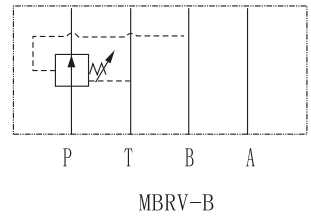
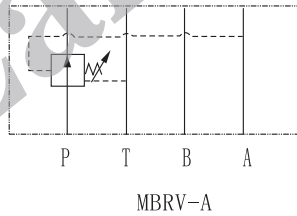
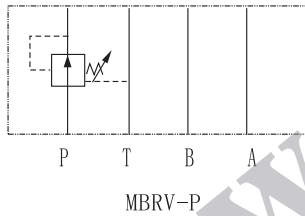

**Dimensions**

Unit: mm

**MBRV-02B**

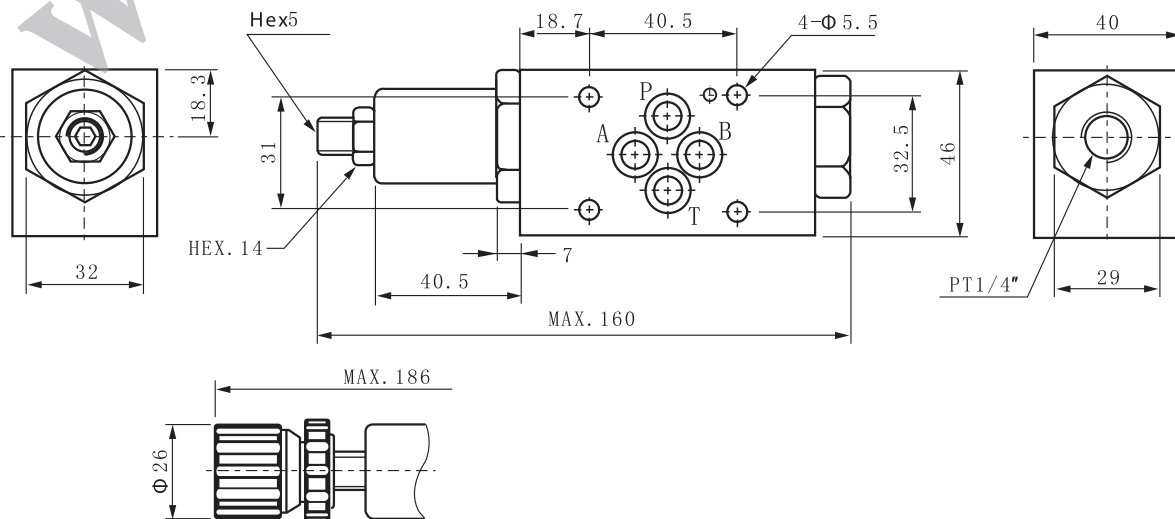

Dimensions

Unit: mm

MBRV-02A/P

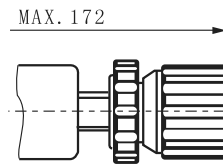
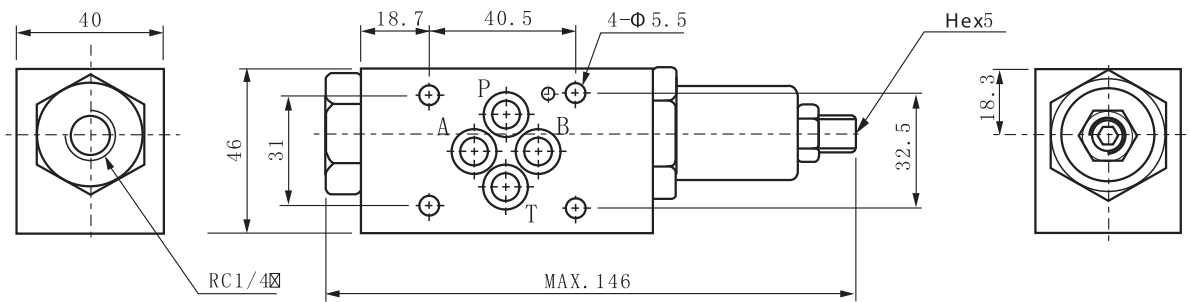

MBRV-03A/B/P

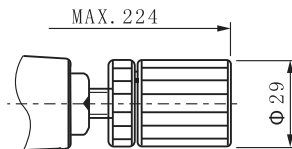
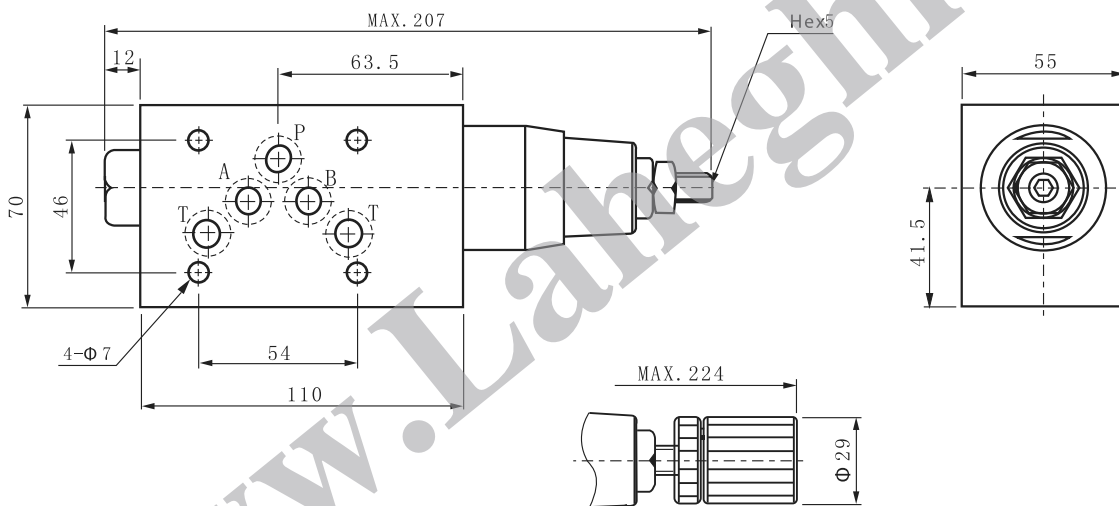

MBRV-04A/B/P

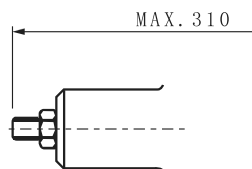
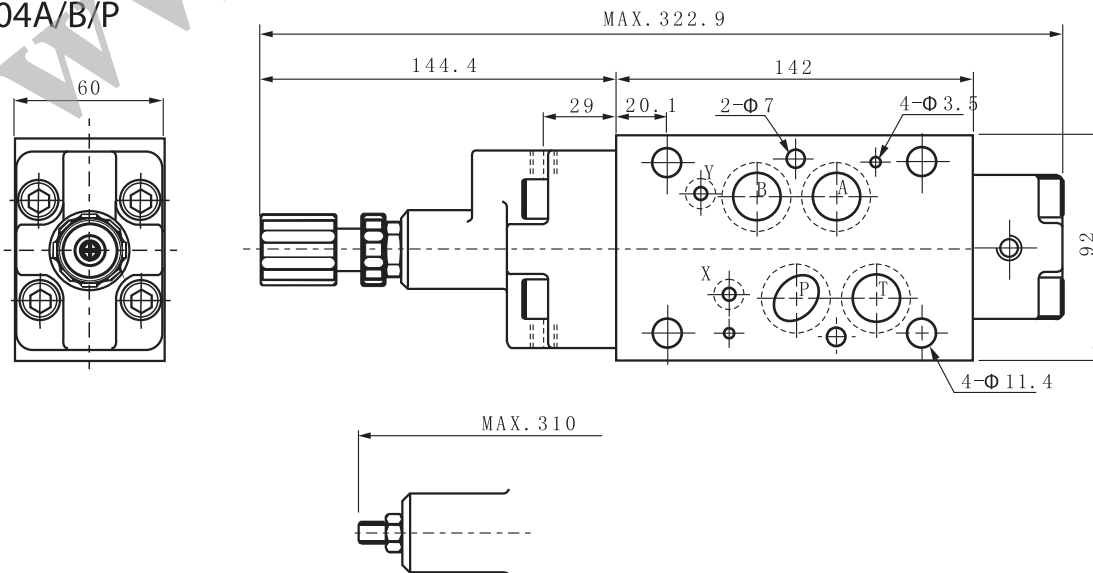

Dimensions

Unit: mm

MBRV-06A/B/P

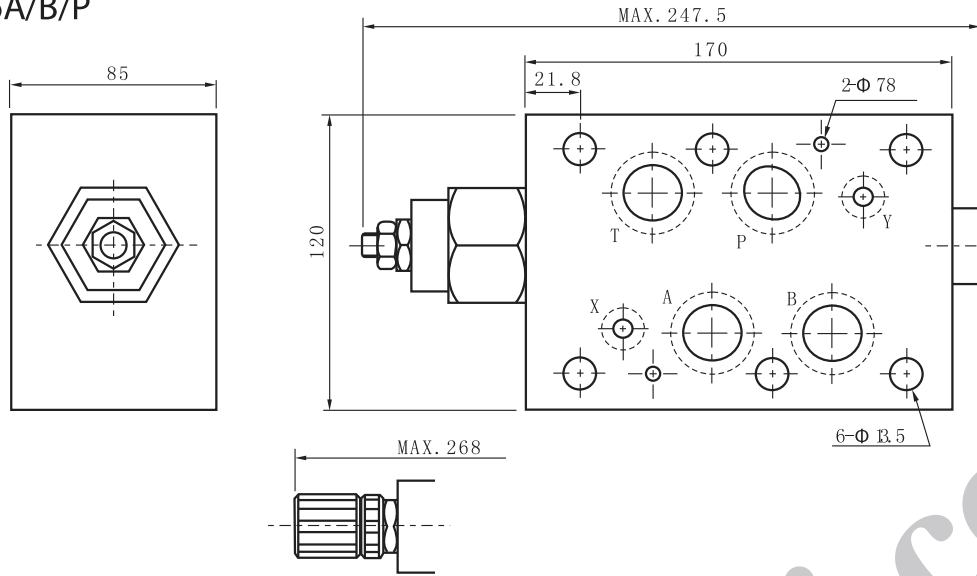

Mounting size

Unit: mm

MBRV-02

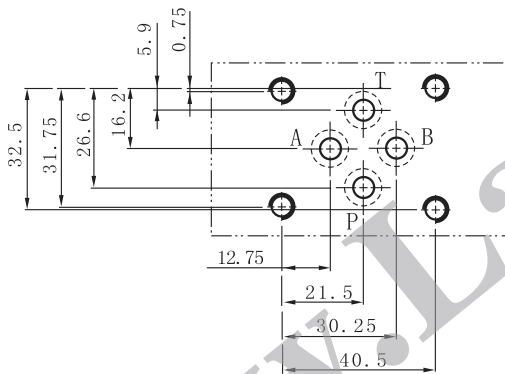

MBRV-03

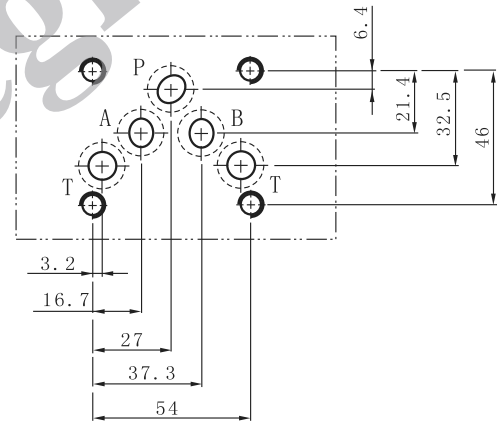

MBRV-04

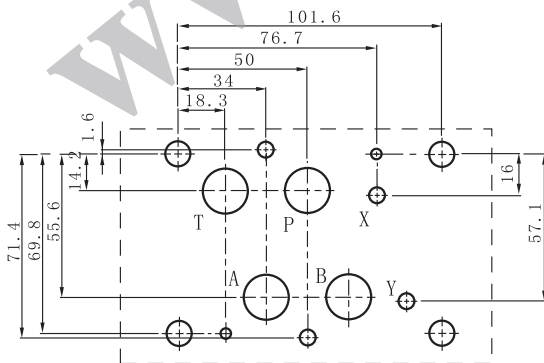

MBRV-06

