



MB-3 SERIES

Monoblock Directional Control Valves

FOR MOBILE AND INDUSTRIAL
HYDRAULIC APPLICATIONS



Innovative Designs
Professional Quality
Customer Satisfaction !



油力油壓工業股份有限公司
YOULI HYDRAULIC INDUSTRIAL CO.,LTD.

公司：41163 台中市太平區溪洲路 87 巷 7 號
工廠：41468 台中市烏日區大明路 145 巷 9 號

OFFICE & FACTORY :

No.9, LANE 145, TAI MING RD., WU ZIH DIST., TAICHUNG CITY, TAIWAN 41468
TEL : 886-4-2335 8996 FAX : 886-4-2335 8997
Http://www.tw-youli.com.tw/ E-mail : sales@tw-youli.com.tw

版權所有 翻印必究
COPY RIGHTS RESERVED

01.2014 / 500 05-136E/S
Survey 04-2322 7907



油力油壓工業股份有限公司
YOULI HYDRAULIC INDUSTRIAL CO.,LTD.

MB-3 Chapters

Monoblock Directional Control Valves

Working condition	P.5
Ordering code	P.6
Dimensions	P.9
Performance data	P.10
Inlet relief options	P.11
Spool options	P.12
A side options	P.19
B side spool positioners	P.23
Other options	P.33
Outlet options	P.36





For Mobile And Industrial Hydraulic Applications.

MONOBLOCK DIRECTIONAL CONTROL VALVES

MB-2 / MB-3 / MB-4 / MB-5 / MSB-5

SECTIONAL DIRECTIONAL CONTROL VALVES

SN-3 / SN-4 / SN-6 / SN-8



MB-2

ONLY ONE SECTION AVAILABLE

Nominal flow rate	45 l/min	12 US gpm
Operating pressure (maximum)	250 bar	3600 psi
Back pressure (maximum) on outlet port T	25 bar	360 psi



MB-3

AVAILABLE SECTIONS FROM 1 TO 7

Nominal flow rate	45 l/min	12 US gpm
Operating pressure (maximum)	315 bar	4600 psi
Back pressure (maximum) on outlet port T	25 bar	360 psi



MB-4

AVAILABLE SECTIONS FROM 1 TO 6

Nominal flow rate	60 l/min	16 US gpm
Operating pressure (maximum)	315 bar	4600 psi
Back pressure (maximum) on outlet port T	25 bar	360 psi



MB-5

AVAILABLE SECTIONS FROM 1 TO 6

Nominal flow rate	80 l/min	21 US gpm
Operating pressure (maximum)	315 bar	4600 psi
Back pressure (maximum) on outlet port T	25 bar	360 psi



MSB-5

AVAILABLE SECTIONS FROM 1 TO 6

With Independent load check valve in each section, and optional port relief.

Nominal flow rate	80 l/min	21 US gpm
Operating pressure (maximum)	315 bar	4600 psi
Back pressure (maximum) on outlet port T	25 bar	360 psi



SN-3

AVAILABLE SECTIONS FROM 1 TO 12

Nominal flow rate	50 l/min	13 US gpm
Operating pressure (maximum)	315 bar	4600 psi
Back pressure (maximum) on outlet port T	25 bar	360 psi



SN-4

AVAILABLE SECTIONS FROM 1 TO 12

Nominal flow rate	80 l/min	21 US gpm
Operating pressure (maximum)	315 bar	4600 psi
Back pressure (maximum) on outlet port T	25 bar	360 psi



SN-6

AVAILABLE SECTIONS FROM 1 TO 12

Nominal flow rate	140 l/min	37 US gpm
Operating pressure (maximum)	315 bar	4600 psi
Back pressure (maximum) on outlet port T	25 bar	360 psi



SN-8

AVAILABLE SECTIONS FROM 1 TO 12

Nominal flow rate	240 l/min	63 US gpm
Operating pressure (maximum)	315 bar	4600 psi
Back pressure (maximum) on outlet port T	25 bar	360 psi

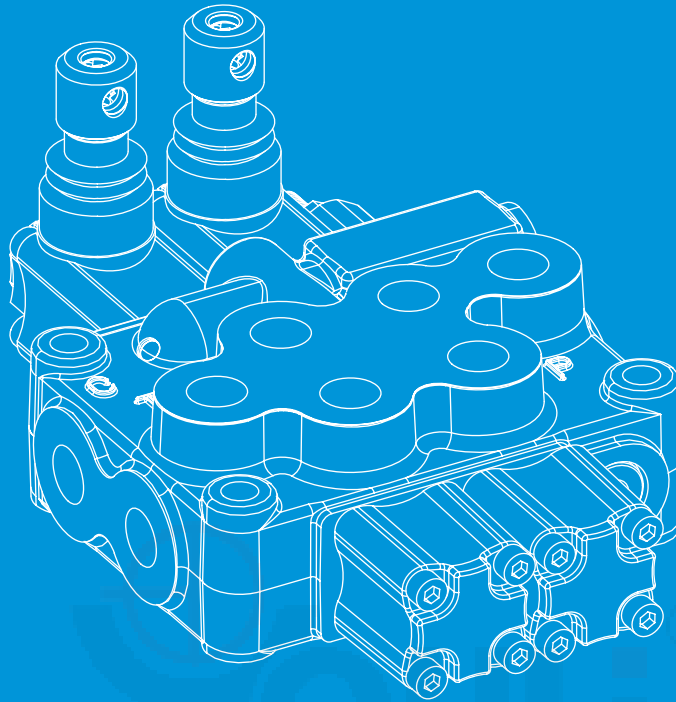

Innovative Designs
Professional Quality
Customer Satisfaction !

AVAILABLE SECTIONS FROM

1 TO 7

MB-3

Monoblock Directional Control Valves



MB-3

Monoblock Directional Control Valves

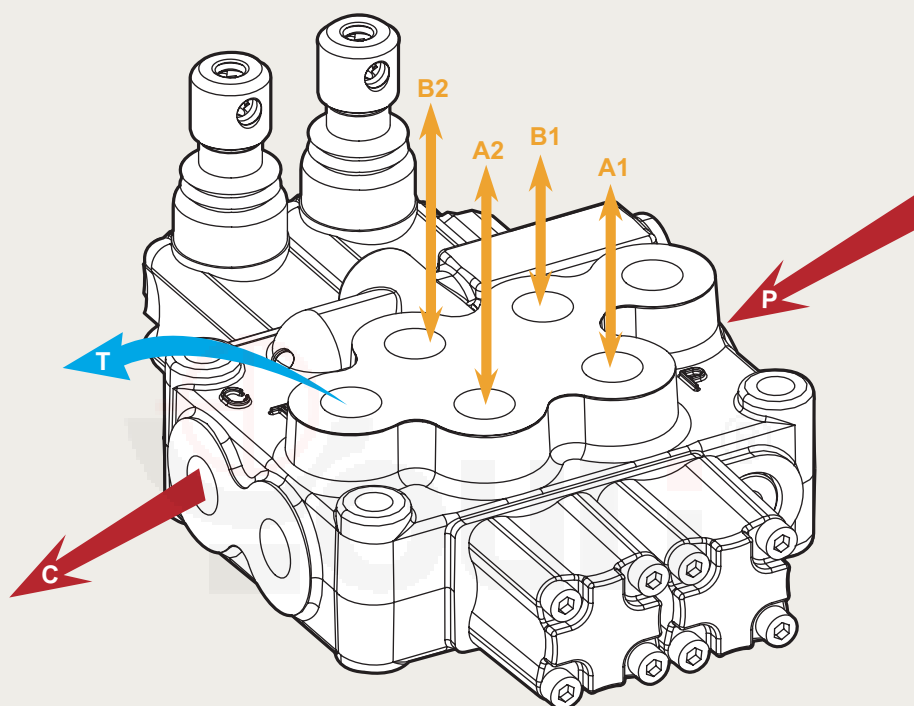

MB-3 Specifications

Nominal flow rate		45 l/min	12 US gpm
Operating pressure (maximum)		315 bar	4600 psi
Back pressure (maximum)	on outlet port T	25 bar	360 psi
Fluid temperature range	with NBR(BUNA-N) seals	from - 20° to 80°C	from - 4° to 176° F
	with FPM(VITON) seal	from - 20° to 100°C	from - 4° to 212° F
Viscosity	operating range	from 15 to 75 mm ² /s	from 15 to 75 cst
	min.	12 mm ² /s	12 cst
	max.	400 mm ² /s	400 cst
Ambient temperature range		from - 40° to 60°C	from - 40° to 140° F

• All specifications, dimensions and design characteristics shown in this catalogue are subject to change without notice.

MB-3

Monoblock Directional Control Valves

MB-3 / **2S** - **3** / **18L** / G-3 / M3
 1 2 3 4 5

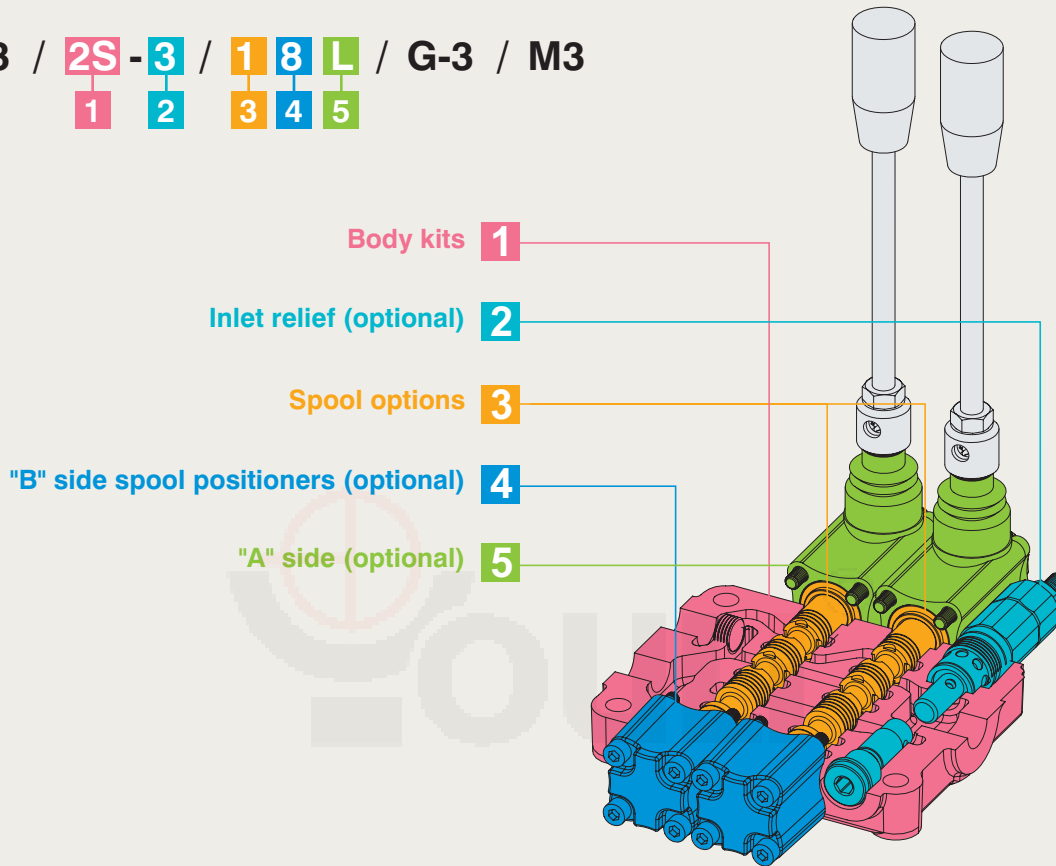

1: Body kits		WITHOUT SERVICE PORT VALVES PREARRANGEMENT (INCLUDE BODY, SEALS, RINGS AND LOAD CHECK VALVE.)
TYPE	DESCRIPTION	
1 - S	1 section	
2 - S	2 sections	
3 - S	3 sections	
4 - S	4 sections	
5 - S	5 sections	
6 - S	6 sections	

2: Inlet Relief (optional)			
TYPE	CODE	DESCRIPTION	PAGE
DG-2	YLMB32002	Range 40 to 80 bar / 580 to 1150 psi, standard setting 80 bar / 1150 psi	P. 11
DG-3	YLMB32003	Range 63 to 200 bar / 900 to 2900 psi, standard setting 120 bar / 1750 psi	P. 11
DG-4	YLMB32004	Range 160 to 315 bar / 2300 to 4600 psi, standard setting 220 bar / 3200 psi	P. 11
SV	YLMB32100	Relief valve blanking plug	P. 11

MB-3

Monoblock Directional Control Valves

3: Spool Options			
TYPE	CODE	DESCRIPTION	PAGE
1	YLMB33001	Double acting, 3 positions, with A, B closed in neutral position	P. 12
2	YLMB33002	Double acting, 3 positions, with A, B open to Tank in neutral position	P. 12
3	YLMB33003	Single acting on A closed in neutral position, 3 positions, B plugged	P. 13
5	YLMB33005	Double acting, 3 positions, with B open to Tank in neutral position	P. 13
6	YLMB33006	Double acting, 3 positions, with A open to Tank in neutral position	P. 14
7	YLMB33007	Single acting on A open to Tank in neutral position, 3 positions, B plugged	P. 14
9	YLMB33009	Double acting, 3 positions, with P, T, A, B closed in neutral position (Closed center)	P. 15
1 0	YLMB33010	Double acting, 3 positions, with A, B open to Tank and P, T closed in neutral position (Closed center)	P. 15
5DY	YLMB33052	Double acting, 4 position, floating circuit in 4th position with A, B open to Tank by pulling the lever	P. 16
5PYX	YLMB330511	Double acting, 4 positions, floating circuit in 4th position with A, B open to Tank by pushing the lever (with check valve)	P. 16
5PY	YLMB33051	Double acting, 4 positions, floating circuit in 4th position with A, B open to Tank by pushing the lever	P. 17
Z41	YLMB33041	Double acting, 4 positions, regenerative circuit in 4th position with P open to A, B by pulling the lever (Rest in pos. 1)	P. 17
Z42	YLMB33042	Double acting, 4 positions, regenerative circuit in 4th position with P open to A, B by pulling the lever (Rest in pos. 0)	P. 18

4: B Side Spool Positioners			
TYPE	CODE	DESCRIPTION	PAGE
6-1	YLMB44061	Detent in pos. 1-0-2, without spring centered	P. 22
6-2	YLMB44062	2 positions, detent in pos. 0-2, without spring centered	P. 22
6-3	YLMB44063	2 positions, detent in pos. 1-0, without spring centered	P. 22
8D2	YLMB44200	With spring return to neutral position and pin with M8 male thread for dual control	P. 22
8EP3	YLMB44300	ON/OFF Electro-Pneumatic actuator	P. 23
8P	YLMB44080	ON/OFF Pneumatic actuator	P. 23
8MG1 (NO)	YLMB44801	Microswitch kit operated in pos. 1 (Normally Open)	P. 26
8MG2 (NO)	YLMB44802	Microswitch kit operated in pos. 2 (Normally Open)	P. 26
8MG3 (NO)	YLMB44803	Microswitch kit operated in pos. 1&2 (Normally Open)	P. 26
MG (NO)	YLMB44804	Microswitch with NO terminal	P. 26
8MG1 (NC)	YLMB448011	Microswitch kit operated in pos. 1 (Normally Closed)	P. 26
8MG2 (NC)	YLMB448021	Microswitch kit operated in pos. 2 (Normally Closed)	P. 26
8MG3 (NC)	YLMB448031	Microswitch kit operated in pos. 1&2 (Normally Closed)	P. 26
MG (NC)	YLMB448041	Microswitch with NC terminal	P. 26
8	YLMB44008	With spring return to neutral position	P. 27
8-1	YLMB44081	2 positions, with spring centered from pos. 1	P. 27
8-2	YLMB44082	2 positions, with spring centered from pos. 2	P. 27
9-1	YLMB44091	Detent in pos. 1, 2 with spring centered	P. 27
9-2	YLMB44092	Detent in pos. 2 with spring centered	P. 27
9-3	YLMB44093	Detent in pos. 1 with spring centered	P. 27

MB-3

Monoblock Directional Control Valves

MB-3 / **2S** - **3** / **1** **8** **L** / **G-3** / **M3**

1 2 3 4 5

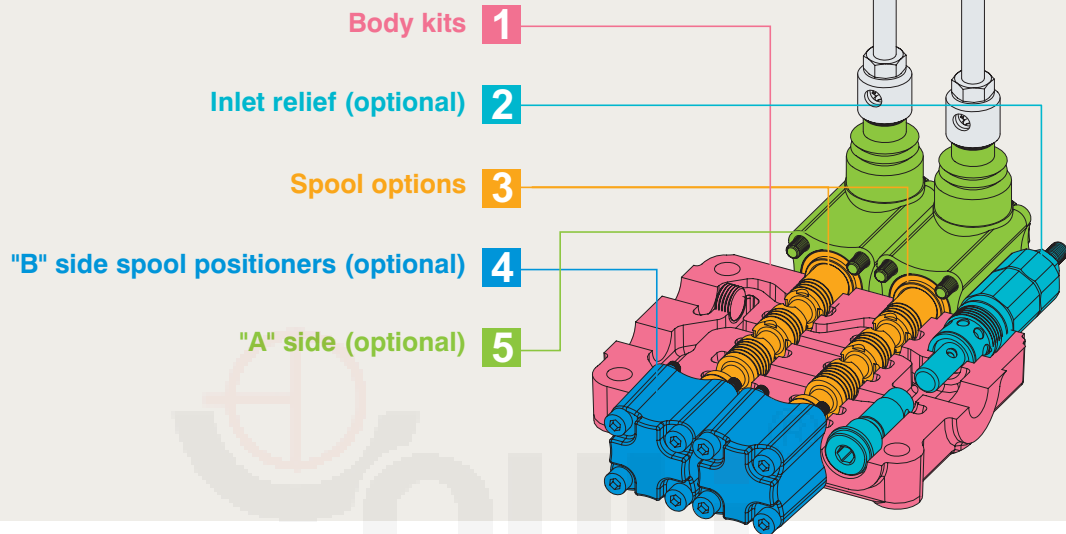

4: B Side Spool Positioners

TYPE	CODE	DESCRIPTION	PAGE
8ED3+RV-KE1R3	YLMB44201	1S: ON/OFF Electro-Hydraulic control kit with pilot and drain line+backpressure valve (12/24 VDC)	P. 24
8ED3+RV-KE2R3	YLMB44202	2S: ON/OFF Electro-Hydraulic control kit with pilot and drain line+backpressure valve (12/24 VDC)	P. 24
8ED3+RV-KE3R3	YLMB44203	3S: ON/OFF Electro-Hydraulic control kit with pilot and drain line+backpressure valve (12/24 VDC)	P. 24
8ED3+RV-KE4R3	YLMB44204	4S: ON/OFF Electro-Hydraulic control kit with pilot and drain line+backpressure valve (12/24 VDC)	P. 24
8ED3+RV-KE5R3	YLMB44205	5S: ON/OFF Electro-Hydraulic control kit with pilot and drain line+backpressure valve (12/24 VDC)	P. 24
8ED3+RV-KE6R3	YLMB44206	6S: ON/OFF Electro-Hydraulic control kit with pilot and drain line+backpressure valve (12/24 VDC)	P. 24
8ER3+KE1S0	YLMB44401	1S: ON/OFF Electro-hydraulic control kit with collector kit for external pilot and drain	P. 25
8ER3+KE2S0	YLMB44402	2S: ON/OFF Electro-hydraulic control kit with collector kit for external pilot and drain	P. 25
8ER3+KE3S0	YLMB44403	3S: ON/OFF Electro-hydraulic control kit with collector kit for external pilot and drain	P. 25
8ER3+KE4S0	YLMB44404	4S: ON/OFF Electro-hydraulic control kit with collector kit for external pilot and drain	P. 25
8ER3+KE5S0	YLMB44405	5S:ON/OFF Electro-hydraulic control kit with collector kit for external pilot and drain	P. 25
8ER3+KE6S0	YLMB44406	6S: ON/OFF Electro-hydraulic control kit with collector kit for external pilot and drain	P. 25

5: A Side (optional)

TYPE	CODE	DESCRIPTION	PAGE
L	YLMB45000	Standard lever box	P. 19
SLP	YLMB45001	Without lever box, with dust-proof plate	P. 19
LCB	YLMB45002	Joystick lever for 2 section operation	P. 20
TQ	YLMB45003	Flexible cable connection	P. 21

MB-3 Dimensions

Monoblock Directional Control Valves

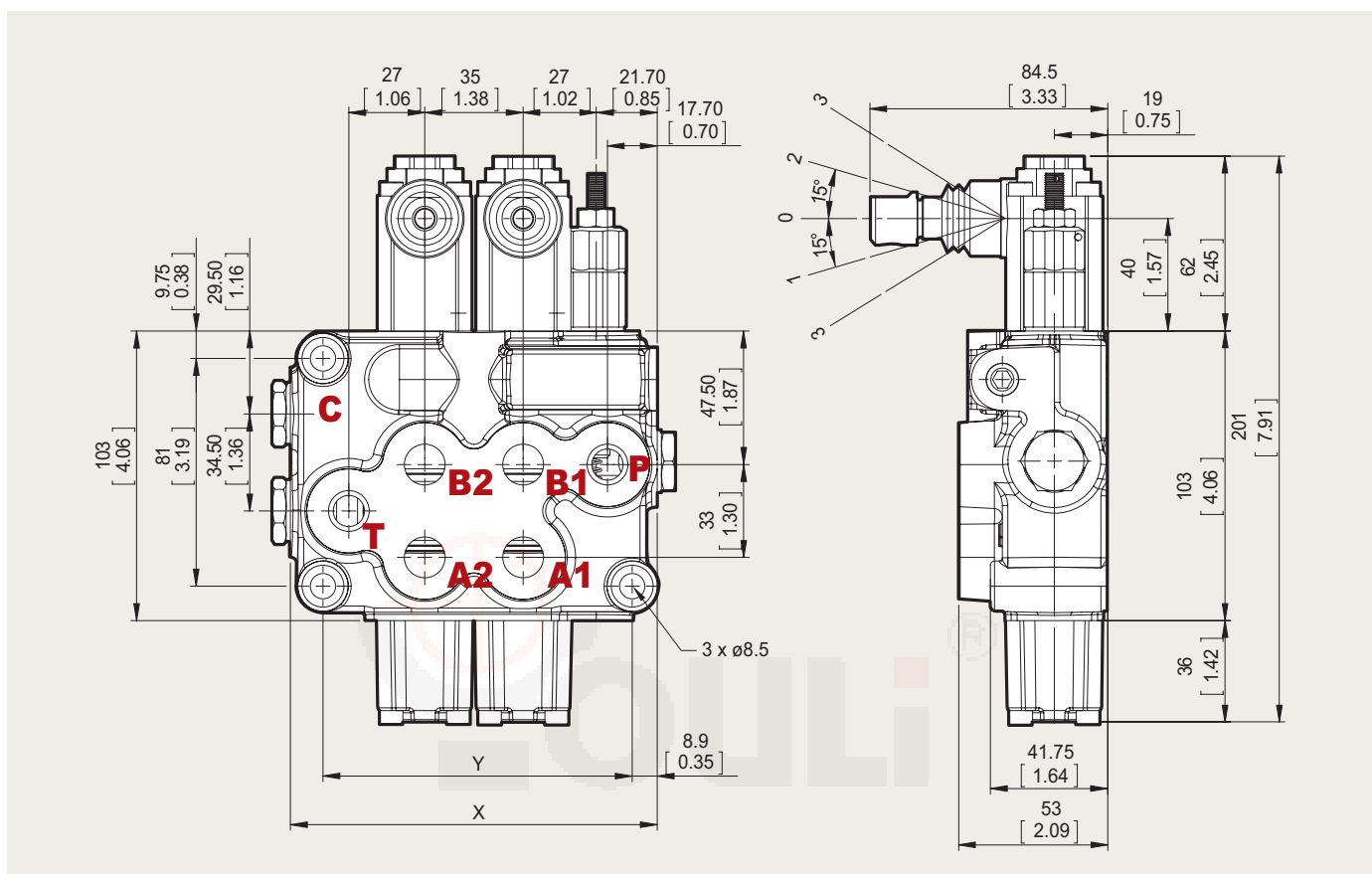

Standard threads

Ports	Inlet P	A and B	Outlet T and C
BSP	G3/8	G3/8	G3/8
UN-UNF	3/4-16 UNF-2B (SAE 8)	3/4-16 UNF-2B (SAE 8)	3/4-16 UNF-2B (SAE 8)
METRIC	M18x1.5	M18x1.5	M18x1.5

• G-3/8 : G3 G-1/2 : G4 G-3/4 : G6 G-1 : G8 G-1 1/4 : G10
 • SAE 8: E8 SAE 10: E10 SAE 12: E12 SAE 16: E16 SAE 20: E20

Standard dimensions

TYPE	X		Y	
	mm	in	mm	in
MB3 /1S	93.5	3.68	73	2.87
MB3 /2S	130.5	5.14	110	4.33
MB3 /3S	165.5	6.52	147	5.79
MB3 /4S	202.5	7.97	184	7.24
MB3 /5S	239.5	9.43	221	8.7
MB3 /6S	276.5	10.89	258	10.16
MB3 /7S	313.5	12.34	295	11.61

MB-3 Performance curve chart

Monoblock Directional Control Valves

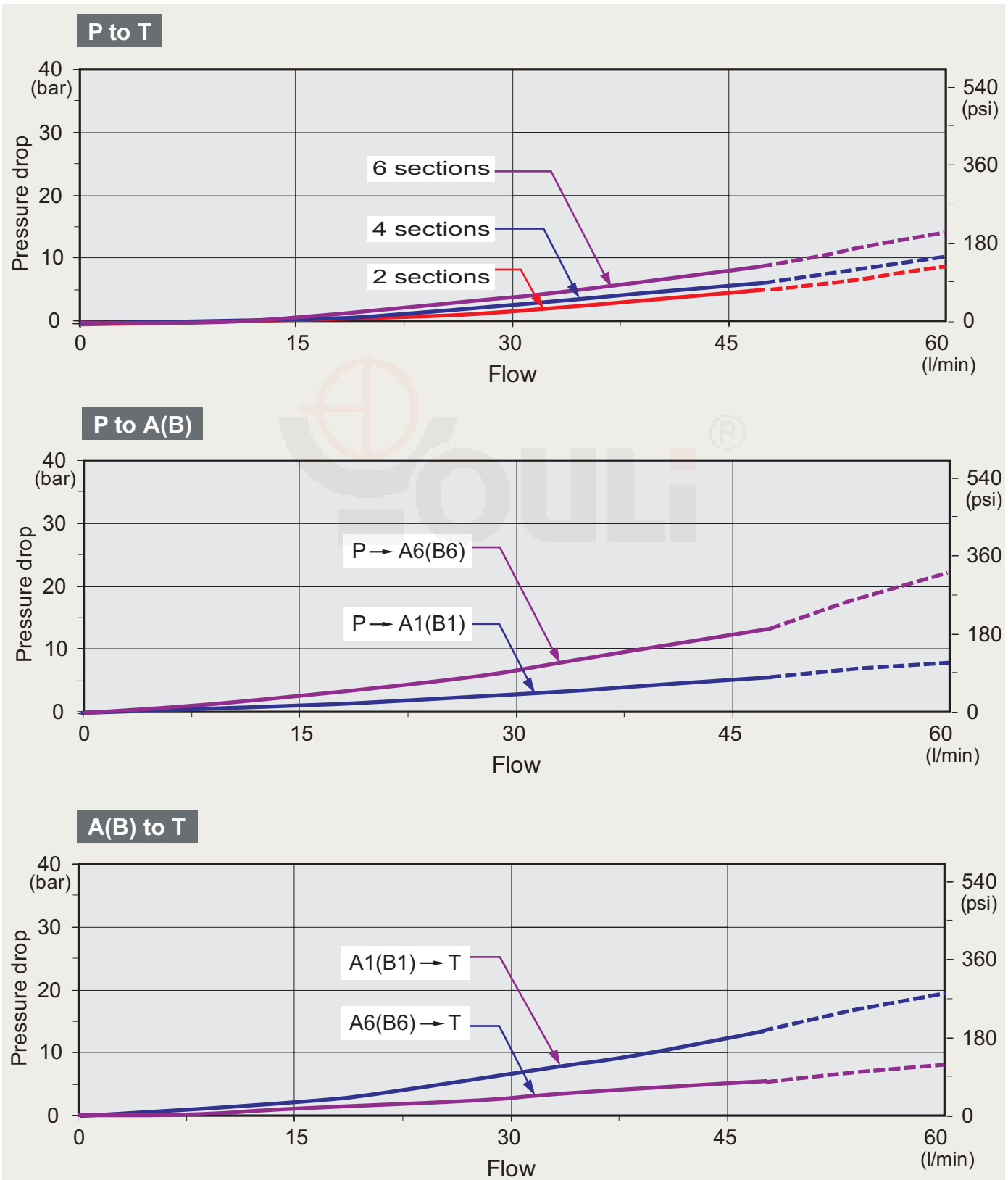

MB-3 Inlet Relief (Optional) Monoblock Directional Control Valves

Type DG

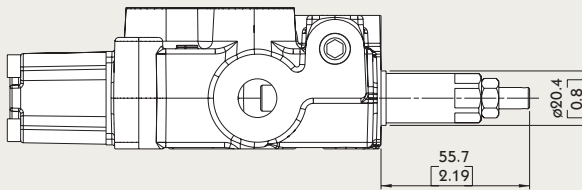

Direct pressure relief valve:

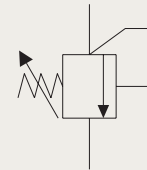

Type SV

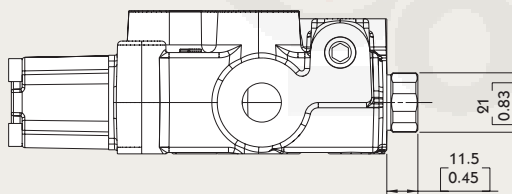

Relief valve blanking plug:

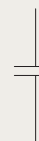

MB-3 spool Options

Monoblock Directional Control Valves

TYPE 1

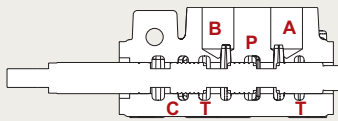

P → A
 B → T
 C closed

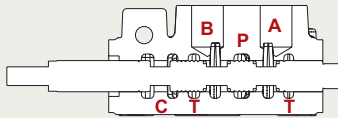
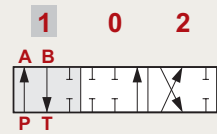

A & B & P & T closed
 C open

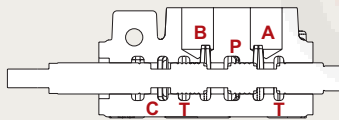
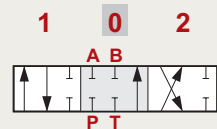

P → B
 A → T
 C closed

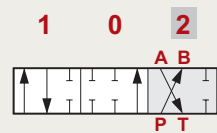

TYPE 2

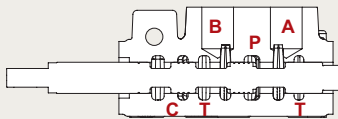

P → A
 B → T
 C closed

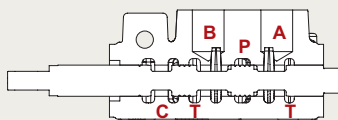
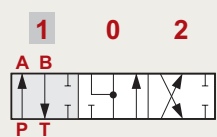

A & B → T
 P closed
 C open

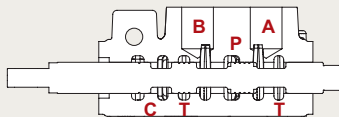
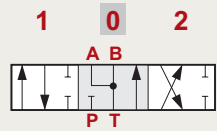

P → B
 A → T
 C closed

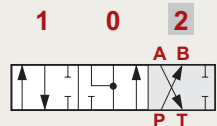

MB-3 Spool Options

Monoblock Directional Control Valves

TYPE 3		
	<p>P → A C & T closed</p>	<p>1 0 2 A P T "B" port plugged</p>
	<p>P & A & T closed C open</p>	<p>1 0 2 A P T "B" port plugged</p>
	<p>A → T P closed C open</p>	<p>1 0 2 A P T "B" port plugged</p>

TYPE 5		
	<p>P → A B → T C closed</p>	<p>1 0 2 A B P T</p>
	<p>B → T A & P closed C open</p>	<p>1 0 2 A B P T</p>
	<p>P → B A → T C closed</p>	<p>1 0 2 A B P T</p>

MB-3 spool Options

Monoblock Directional Control Valves

TYPE 6

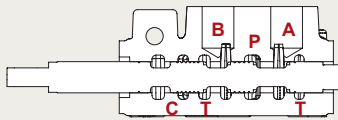

P → A
 B → T
 C closed

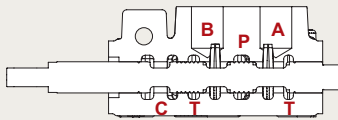
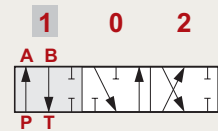

A → T
 P & B closed
 C open

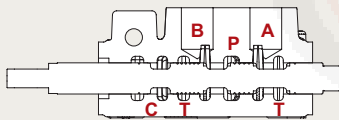
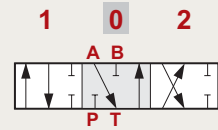

P → B
 A → T
 C closed

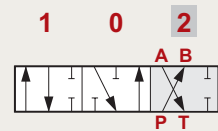

TYPE 7

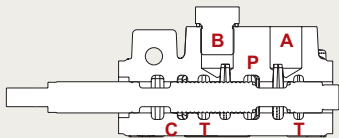

P → A
 C & T closed

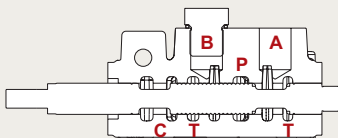
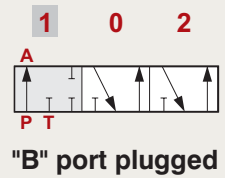

A → T
 P closed
 C open

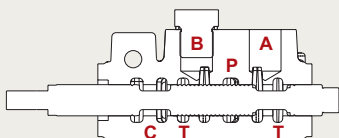
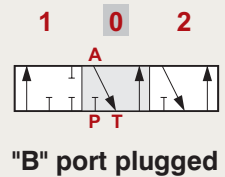

A → T
 P closed
 C open

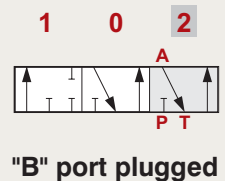

MB-3 Spool Options

Monoblock Directional Control Valves

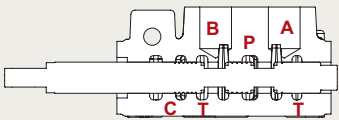
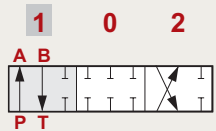
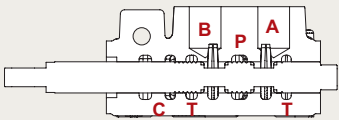
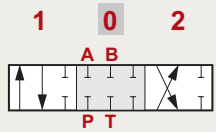
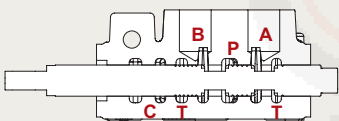
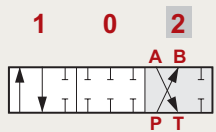
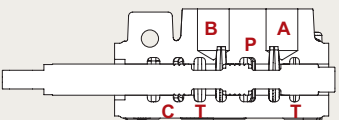
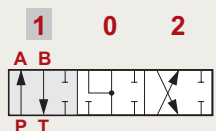
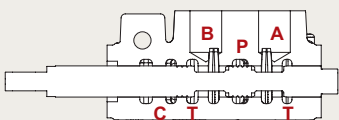
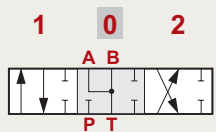
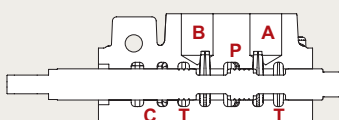
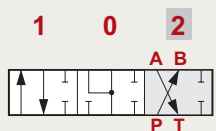
TYPE 9		
	<p>P → A B → T C closed</p>	
	<p>A & B & P & T closed C closed</p>	
	<p>P → B A → T C closed</p>	
TYPE 10		
	<p>P → A B → T C closed</p>	
	<p>A & B → T P & C closed</p>	
	<p>P → B A → T C closed</p>	

MB-3 Spool Options

Monoblock Directional Control Valves

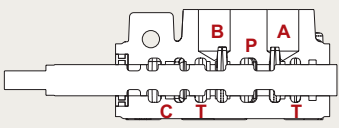
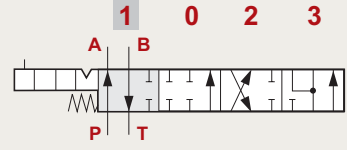
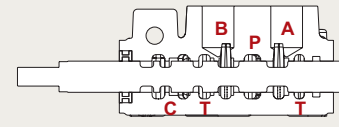
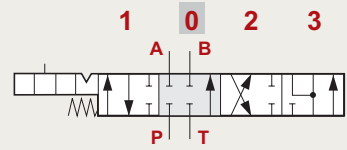
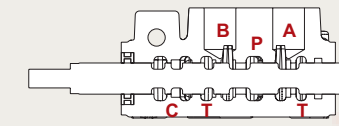
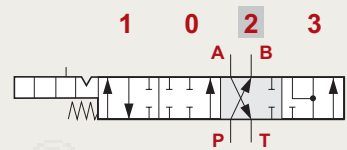
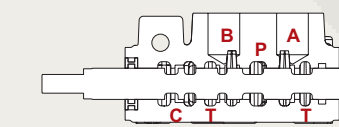
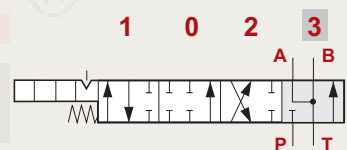
TYPE 5DY		NOTE: WITH SPECIAL BODY AND SPECIAL POSITIONER	
	<p>P → A</p> <p>B → T</p> <p>C closed</p>		
	<p>P & A & B & T closed</p> <p>C open</p>		
	<p>P → B</p> <p>A → T</p> <p>C closed</p>		
	<p>A & B → T</p> <p>P closed</p> <p>C open</p>		

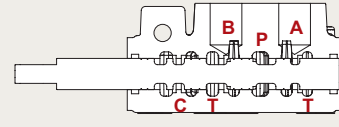
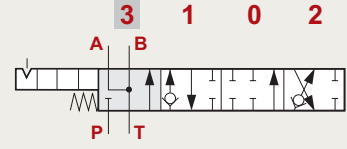
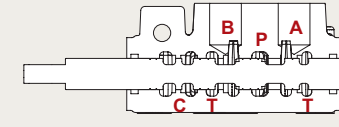
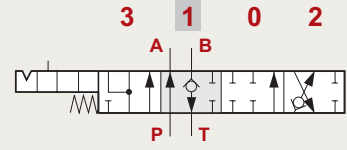
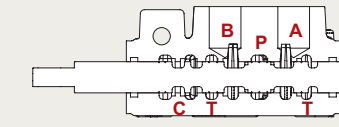
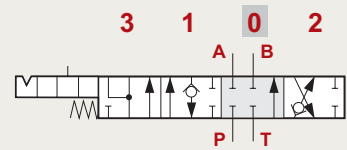
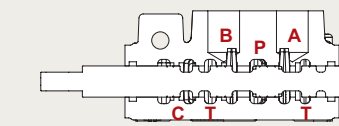
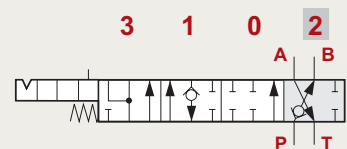
TYPE 5PYX		NOTE: WITH SPECIAL BODY AND SPECIAL SPECIAL POSITIONER	
	<p>A & B → T</p> <p>P closed</p> <p>C open</p>		
	<p>P → A</p> <p>B → T</p> <p>C closed</p>		
	<p>P & A & B & T closed</p> <p>C open</p>		
	<p>P → B</p> <p>A → T</p> <p>C closed</p>		

MB-3 Spool Options

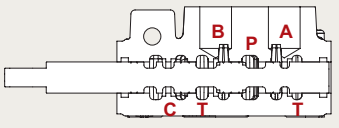
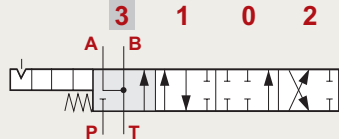
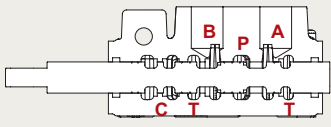
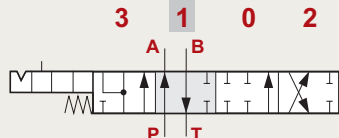
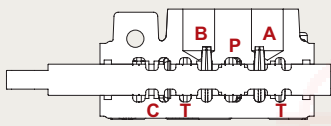
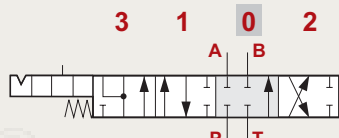
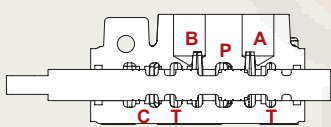
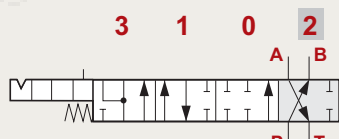

Monoblock Directional Control Valves

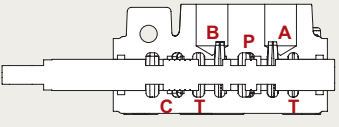
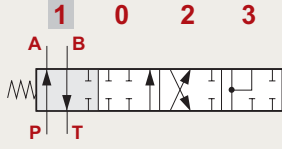
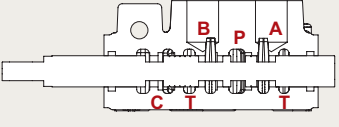
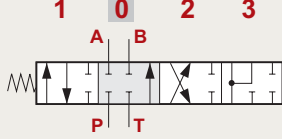
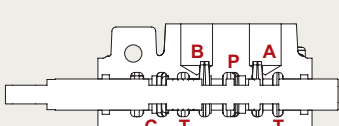
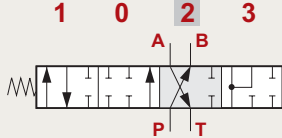
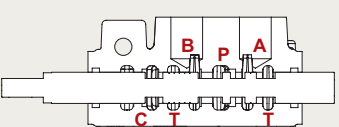
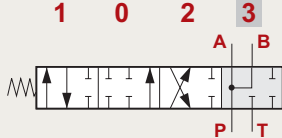
TYPE 5PY	NOTE: WITH SPECIAL BODY AND SPECIAL POSITIONER	
	<p>A & B → T P closed C open</p>	
	<p>P → A B → T C closed</p>	
	<p>P & A & B & T closed C open</p>	
	<p>P → B A → T C closed</p>	

TYPE Z41	NOTE: WITH SPECIAL BODY AND SPECIAL POSITIONER	
	<p>P → A B → T C closed</p>	 <p>Rest in pos. 1</p>
	<p>P & A & B & T closed C open</p>	
	<p>P → B A → T C closed</p>	
	<p>P → A & B T & C closed</p>	

MB-3 Spool Options

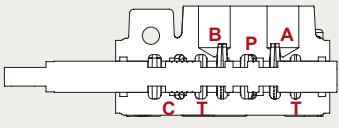
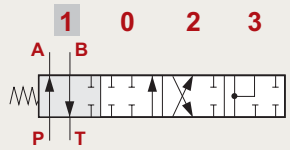
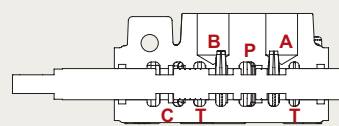
Monoblock Directional Control Valves

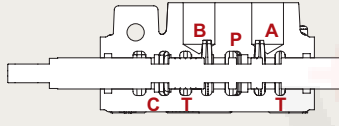
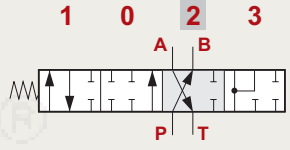
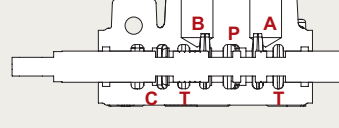
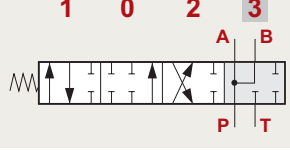
TYPE Z42	NOTE: WITH SPECIAL BODY AND SPECIAL POSITIONNER	
	<p>P → A B → T C closed</p>	
	<p>P & A & B & T closed C open</p>	 <p>Rest in pos. 0</p>
	<p>P → B A → T C closed</p>	
	<p>P → A & B T & C closed</p>	

MB-3 A Side

Monoblock Directional Control Valves

Type L

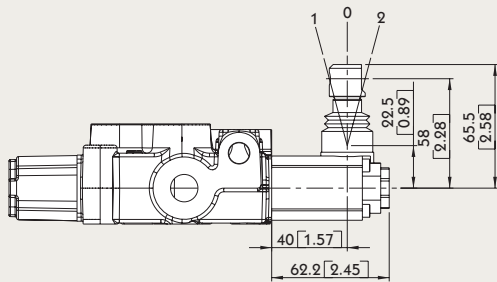

Type L :
STANDART LEVER KIT

Type R

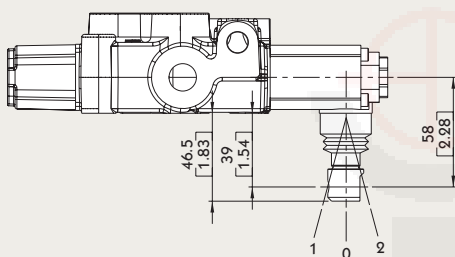

Type R :
STANDART LEVER KIT
(ROTATED 180 DEGREE)

Type SL

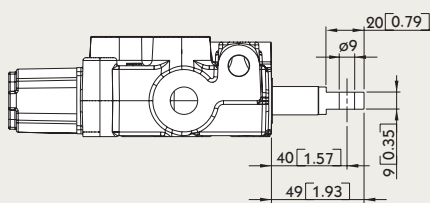

Type SL :
WITHOUT ANY COVER

Type SLP

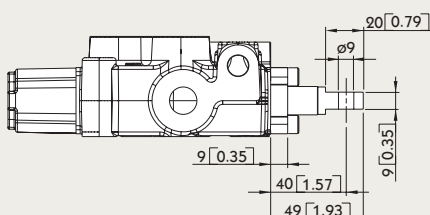

Type SLP :
WITH DUST-PROOF PLATE

MB-3 A Side

Monoblock Directional Control Valves

LCB: Joystick control

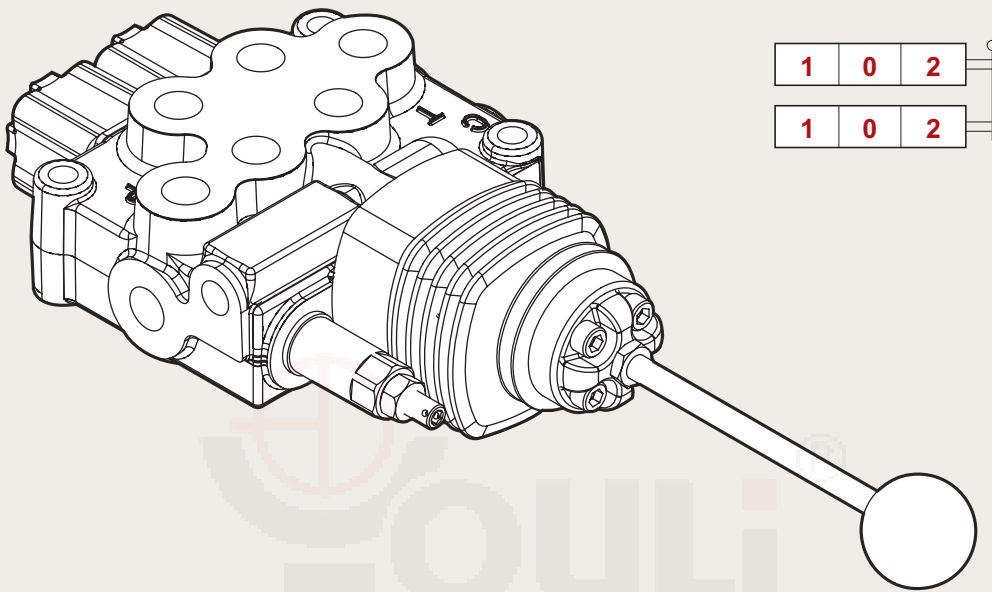

Type LCB

LCB1

LCB2

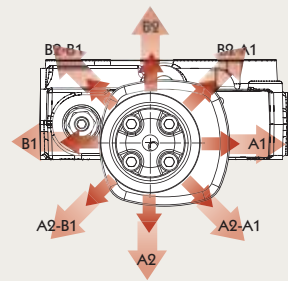
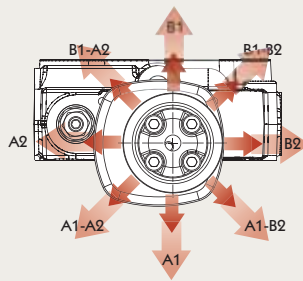
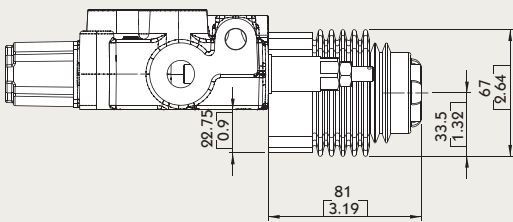

Type LCB

LCB3

LCB4

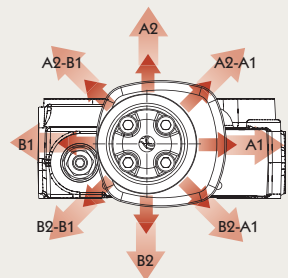
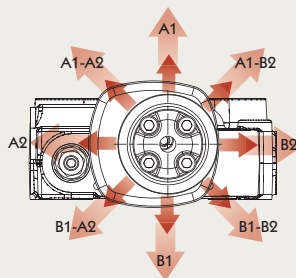
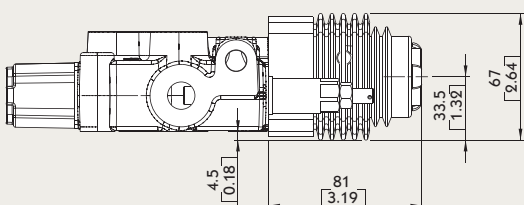

MB-3 A Side

Monoblock Directional Control Valves

Note : CONNECTION KIT NOT INCLUDE CABLE

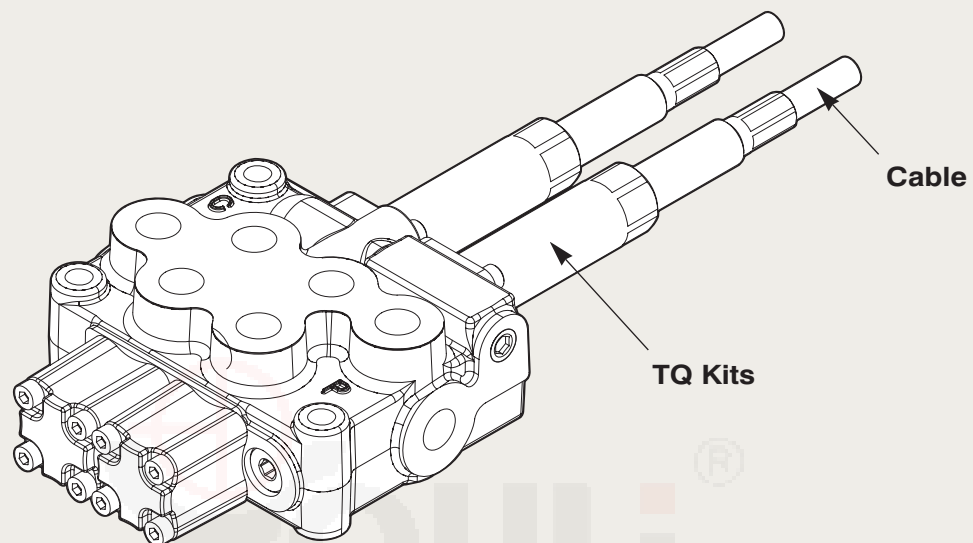

Type TQ

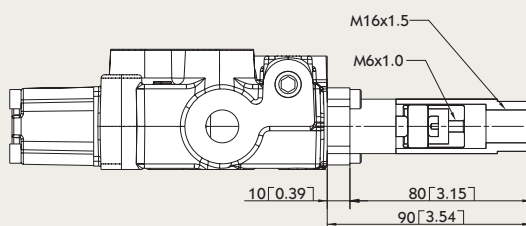

TQ Kit:



MB-3 A Side

Monoblock Directional Control Valves

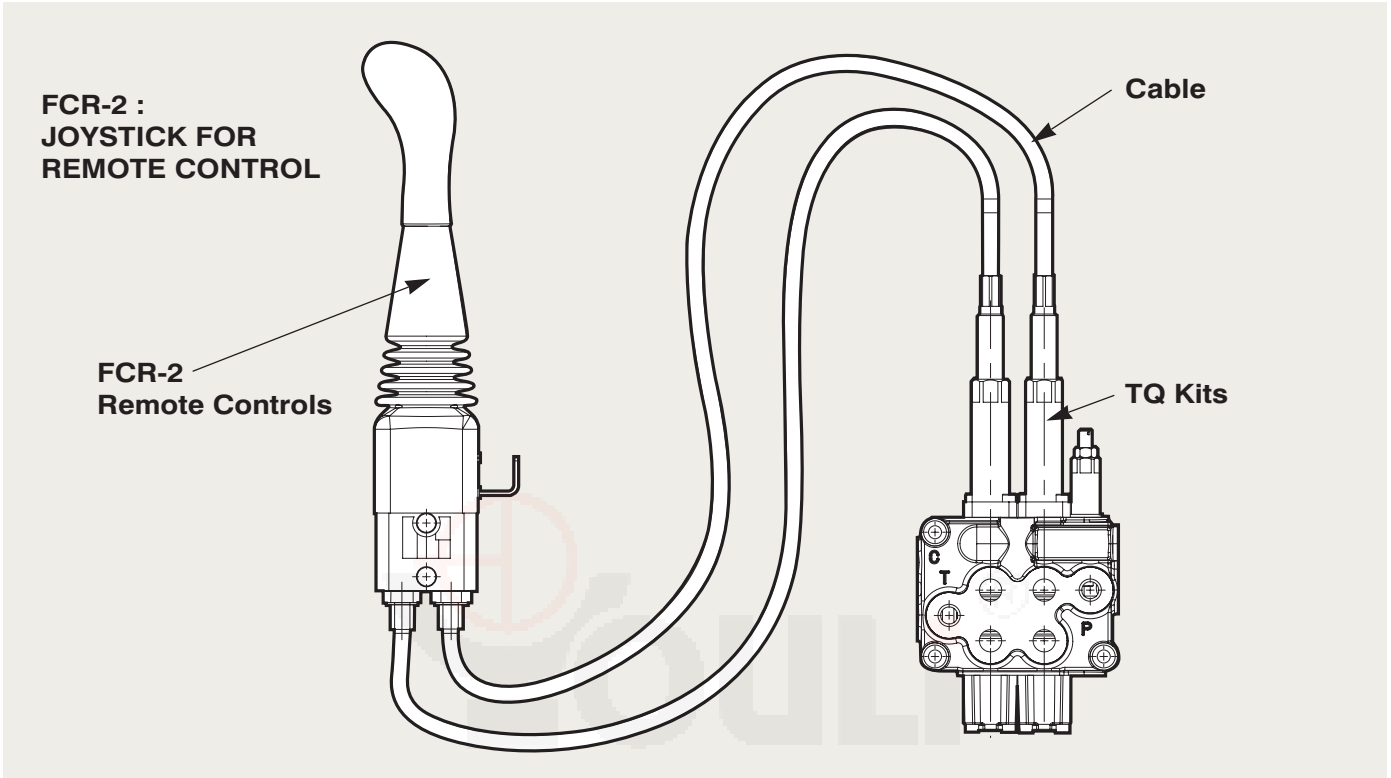

Type FCR-2

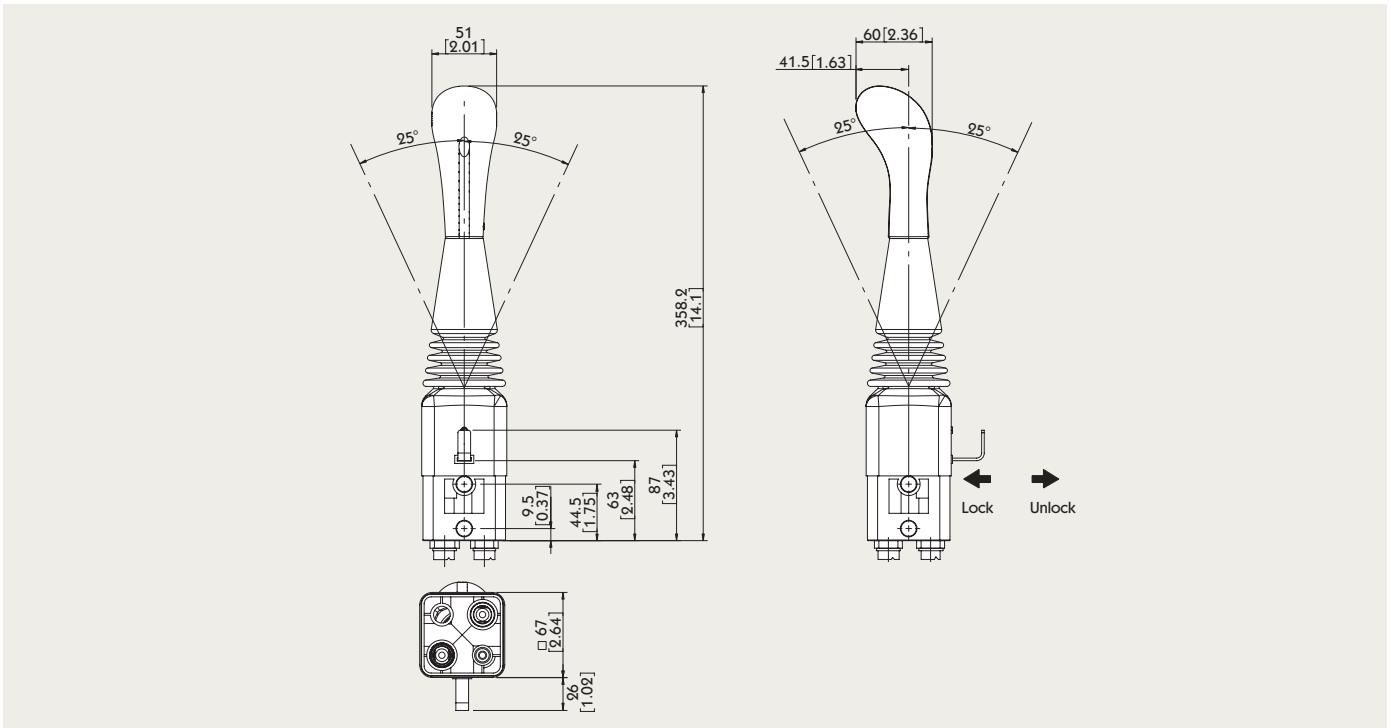

MB-3 B Side

Monoblock Directional Control Valves

Type 6

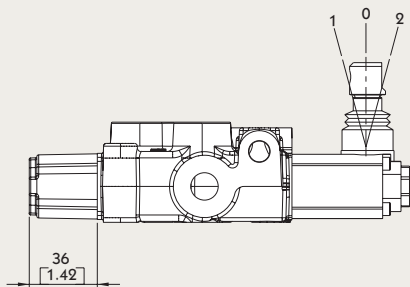

6-1 Kit:

DETENT IN POS. 1-0-2, WITHOUT SPRING CENTERED



6-2 Kit:

2 POSITIONS, DETENT IN POS. 0-2, WITHOUT SPRING CENTERED



6-3 Kit:

2 POSITIONS, DETENT IN POS. 1-0, WITHOUT SPRING CENTERED

Type 8D2

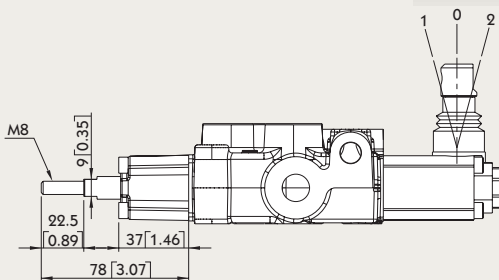

8D2 Kit:

WITH SPRING RETURN TO NEUTRAL POSITION AND PIN WITH M8 MALE THREAD FOR DUAL CONTROL

Type 81M

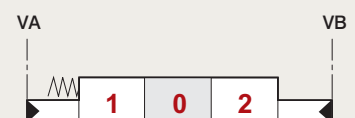
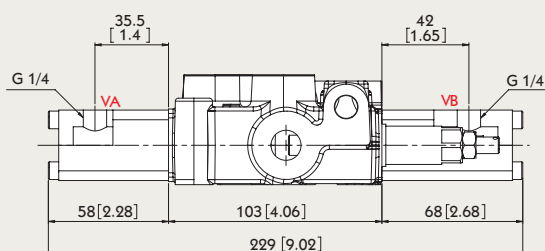

Operating features :

PILOT PRESSURE : MAX. 50 BAR

INTERNAL LEAKAGE A(B) -> T : MAX. 6 CM³/MIN (100 BAR / 40°C)

MB-3 B Side

Monoblock Directional Control Valves

Type 8P

V1 & V2: NPT 1/8 - 27

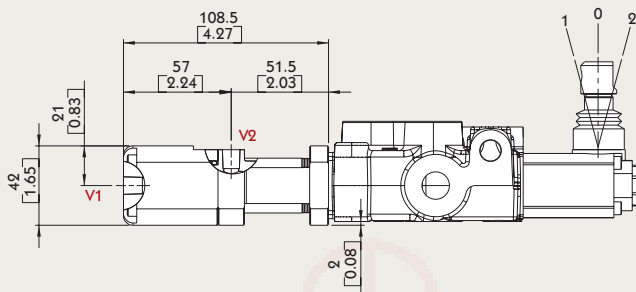

Operating feature :

PILOT PRESSURE (MIN.): 5.5 BAR / 80 PSI
 PILOT PRESSURE (MAX.): 10 BAR / 145 PSI

Type 8EP3

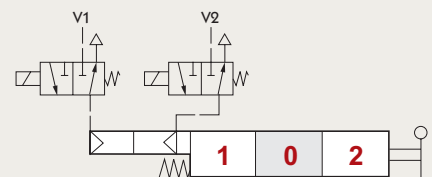
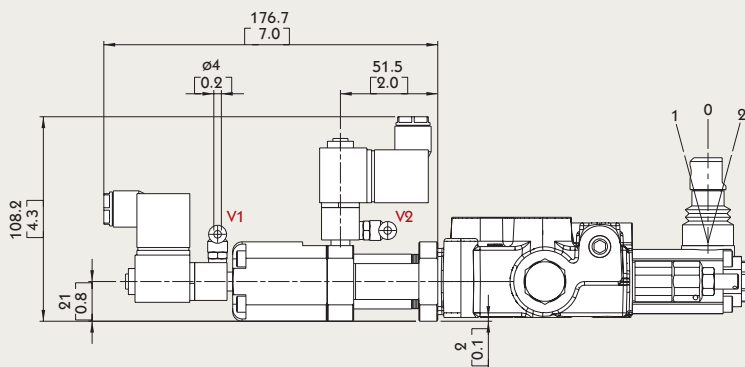

Solenoid operating features :

NOMINAL VOLTAGE: 24VDC
 NOMINAL VOLTAGE TOLERANCE: $\pm 10\%$
 POWER RATING: 5W

MB-3 B Side

Monoblock Directional Control Valves

Type 8ED3

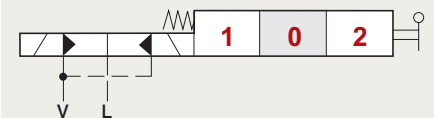
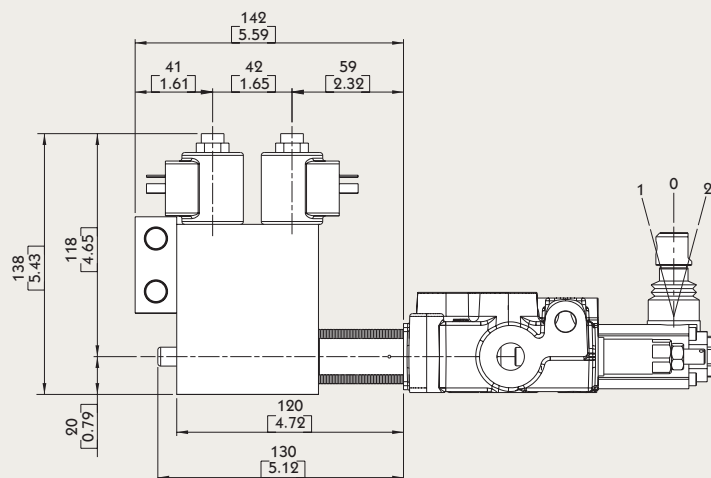
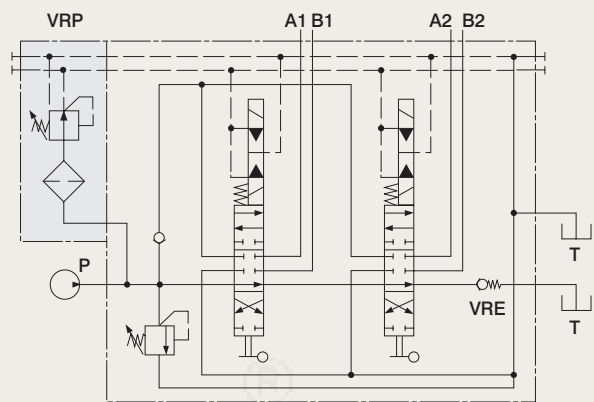
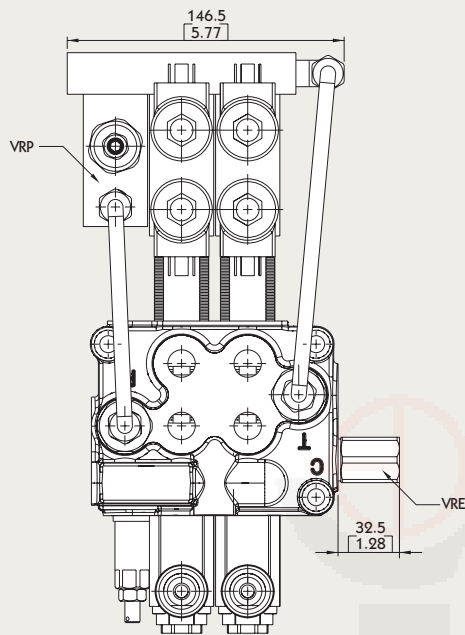

Operating features :

- PILOT PRESSURE: • MIN. 10 BAR / 145 PSI
 • MAX. 50 BAR / 725 PSI
- MAX. BACKPRESSURE ON DRAIN L: 25 BAR / 360PSI

Coil features :

- NOMINAL VOLTAGE TOLERANCE: $\pm 10\%$
 ELECTRIC POWER: 21 W
 STANDARD VOLTAGE: 12 VDC / 24 VDC

MB-3 B Side

Monoblock Directional Control Valves

Type 8ER3

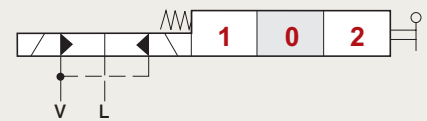
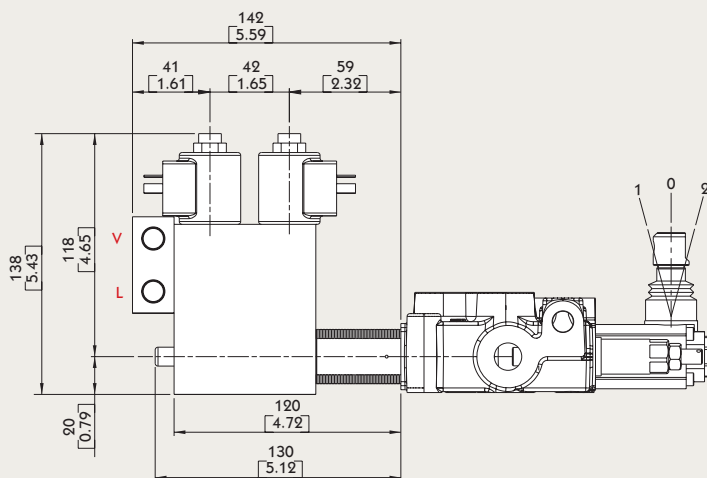
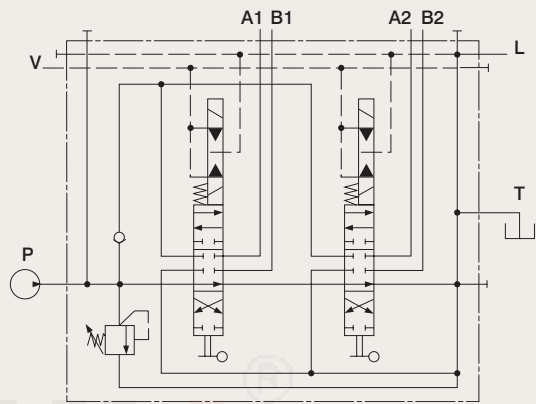
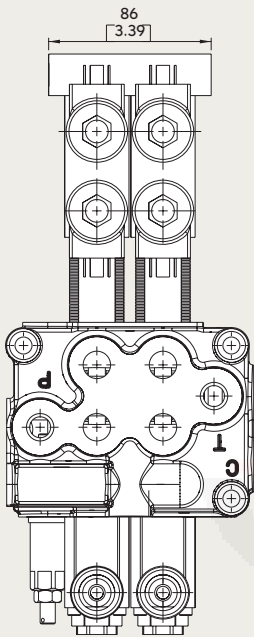

Operating features :

PILOT PRESSURE: • MIN. 10 BAR / 145 PSI
 • MAX. 50 BAR / 725 PSI
 MAX. BACKPRESSURE ON DRAIN L: 25 BAR / 360PSI

Coil features :

NOMINAL VOLTAGE TOLERANCE: $\pm 10\%$
 ELECTRIC POWER: 21 W
 STANDARD VOLTAGE: 12 VDC / 24 VDC

MB-3 B Side

Monoblock Directional Control Valves

Type 8MG

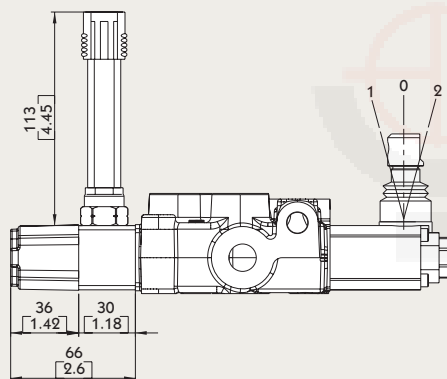

MICROSWITCH

Operating features :

MECHANICAL LIFE: • 5X10⁶ OPERATIONS

ELECTRICAL LIFE (RESISTIVE LOAD):

- 10⁶ OPERATIONS - 7A / 13.5 VDC
- 5x10⁴ OPERATIONS - 10A / 12 VDC
- 5x10⁴ OPERATIONS - 3A / 28 VDC

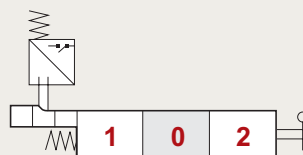

8MG1 Kit:

MICROSWITCH WITH MALE/FEMALE CONNECTOR, OPERATED IN POS. 1



8MG2 Kit:

MICROSWITCH WITH MALE/FEMALE CONNECTOR, OPERATED IN POS. 2

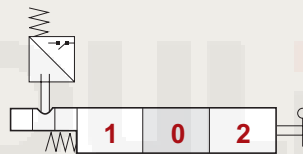

8MG3 Kit:

MICROSWITCH WITH MALE/FEMALE CONNECTOR, OPERATED IN POS. 1 AND POS. 2

With NO contact (female connector with male end)

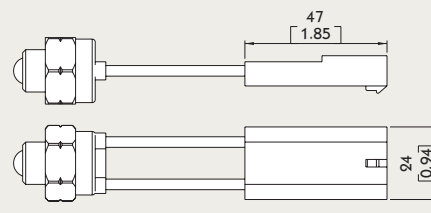

With NC contact (male connector with female end)

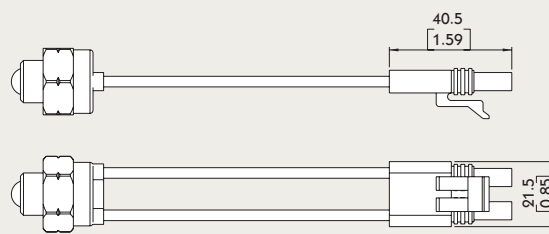

MB-3 B Side

Monoblock Directional Control Valves

Type 8

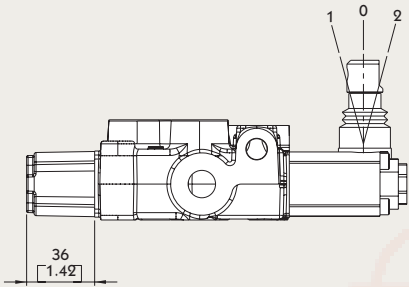

8 Kit:

SPRING RETURN TO NEUTRAL POSITION.



8-1 Kit:

SPRING RETURN TO NEUTRAL POSITION.
(2 POSITIONS)



8-2 Kit:

SPRING RETURN TO NEUTRAL POSITION.
(2 POSITIONS)

Type 9

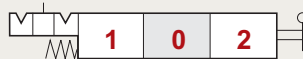
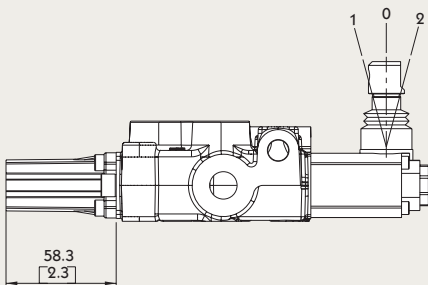

9-1 Kit:

DETENT IN POS. 1, 2 WITH SPRING CENTERED



9-2 Kit:

DETENT IN POS. 2 WITH SPRING CENTERED



9-3 Kit:

DETENT IN POS. 1 WITH SPRING CENTERED

MB-3 B Side (Optional controls)

Monoblock Directional Control Valves

Electric wiring example

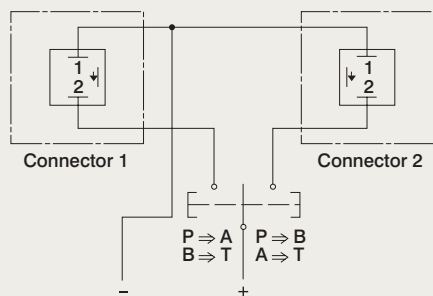

Coil features :

NOMINAL VOLTAGE TOLERANCE: $\pm 10\%$
 ELECTRIC POWER: 36 W
 STANDARD VOLTAGE: 12 VDC / 24 VDC

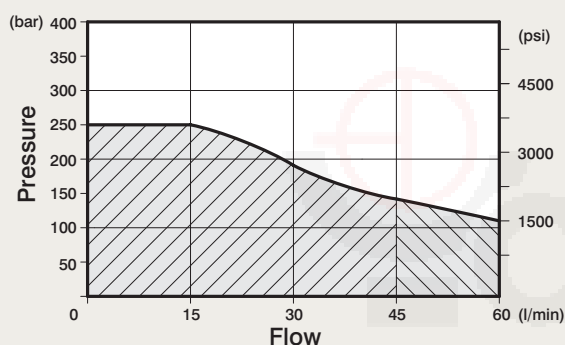
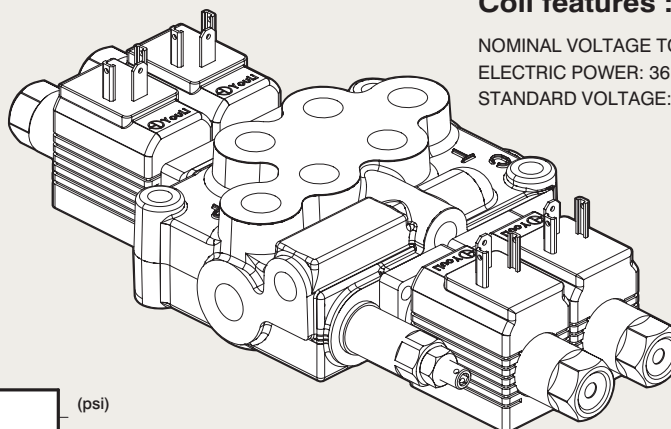

Nominal flow rating		45 L/min	12 US gpm
Operating pressure (Max.)		250 bar	3650 psi
Back pressure (Max.)	on outlet port T	5 bar	70 psi
Fluid temperature	with NBR seals	-20°C~80°C	-4°F~176°F
	with FPM seals	-20°C~100°C	-4°F~212°F
Viscosity	Operating range	15mm ² /s~75mm ² /s	15~75 cst
	Max.	400mm ² /s	400 cst
	Min.	12mm ² /s	12 cst
Ambient temperature		-40°C~60°C	-40°F~140°F
Internal Leakage A(B)->T	$\Delta P = 100\text{bar at } 40^\circ\text{C}$	10 cm ³ /min	0.61 in ³ /min

Type 8ES

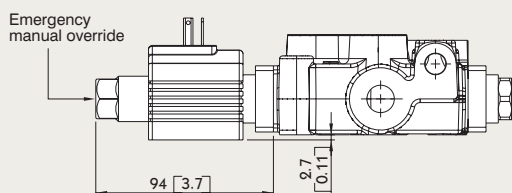

8ES1 Kit:
ACTING IN 1

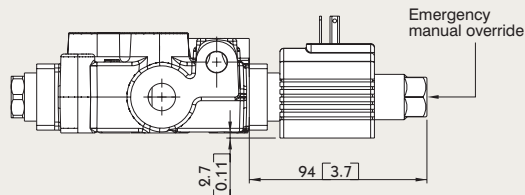

8ES2 Kit:
ACTING IN 2

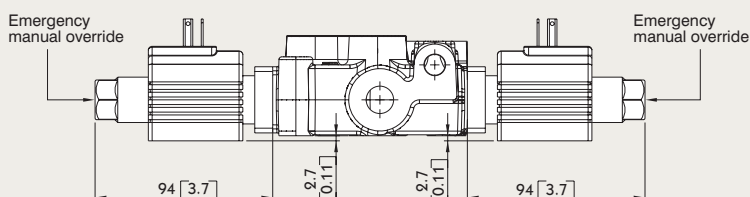

8ES3 Kit:
ACTING IN 1 & 2

MB-3 B Side (Optional controls) Monoblock Directional Control Valves

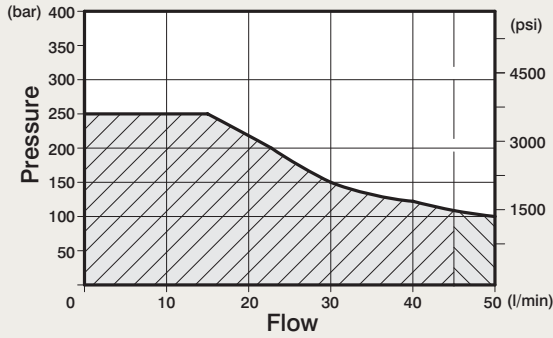

Nominal flow rating		45 L/min	12 US gpm
Operating pressure (Max.)		250 bar	3650 psi
Back pressure (Max.)	on outlet port T	5 bar	70 psi
Fluid temperature	with NBR seals	-20°C~80°C	-4°F~176°F
	with FPM seals	-20°C~100°C	-4°F~212°F
Viscosity	Operating range	15mm ² /s~75mm ² /s	15~75 cst
	Max.	400mm ² /s	400 cst
	Min.	12mm ² /s	12 cst
Ambient temperature		-40°C~60°C	-40°F~140°F
Internal Leakage A(B)->T	ΔP = 100bar at 40°C	10 cm ³ /min	0.61 in ³ /min

Available sections from 1 to 3 section

Electric wiring example

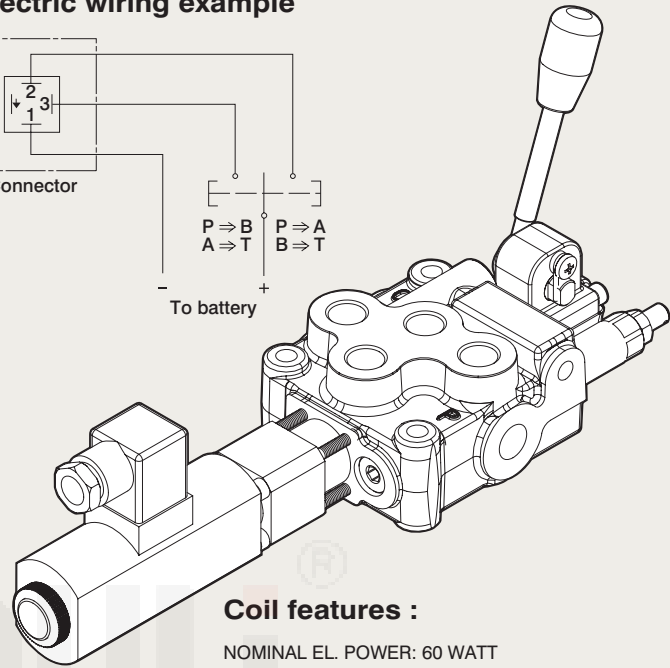
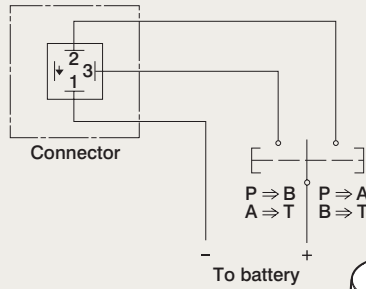

Coil features :

NOMINAL EL. POWER: 60 WATT
LIMITS OF AMBIENT TEMPERATURE : -20°C +70°C
STANDARD VOLTAGE: 12 - 24 VDC (±10%)

Type 8ESN

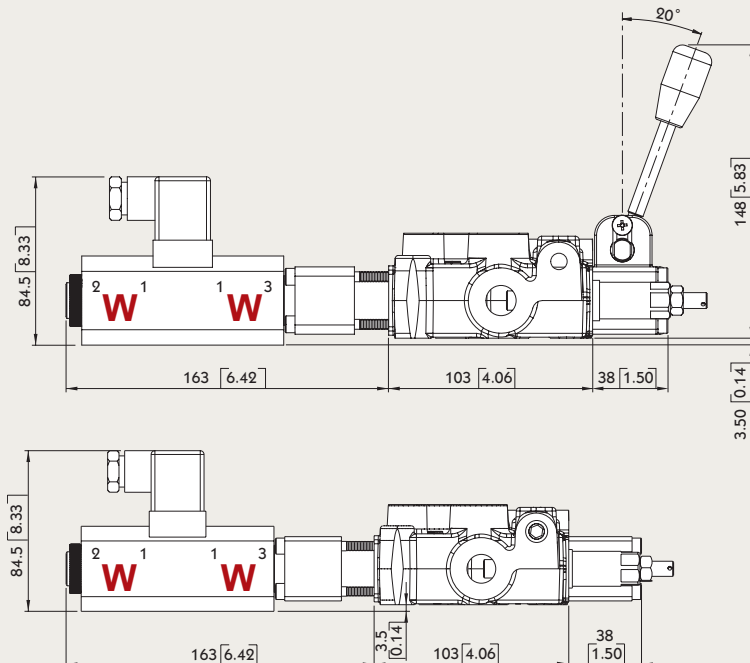

8ESNLES Kit:



8ESNCAE Kit:



MB-3 Special spool (Options for 8ES Kit)

Monoblock Directional Control Valves

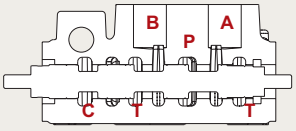
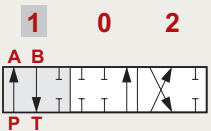
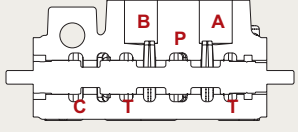
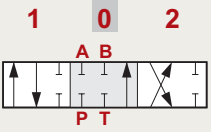
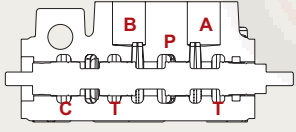
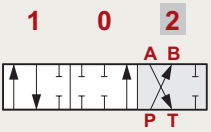
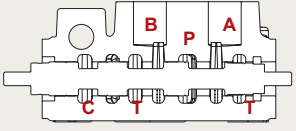
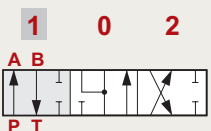
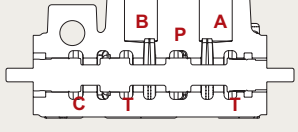
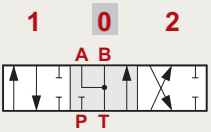
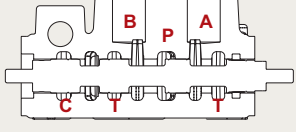
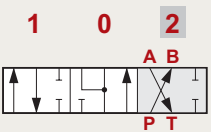
Type 8ES3#1		
	<p>P → A B → T C closed</p>	
	<p>A & B & P & T closed C open</p>	
	<p>P → B A → T C closed</p>	
Type 8ES3#2		
	<p>P → A B → T C closed</p>	
	<p>A & B → T P closed C open</p>	
	<p>P → B A → T C closed</p>	

MB-3 special spool (Options for 8ESN Kit)

Monoblock Directional Control Valves

Type 8ESN#1

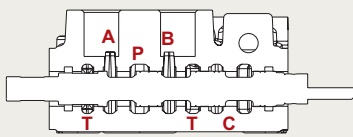

P → A
 B → T
 C closed

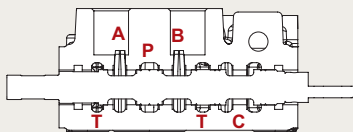
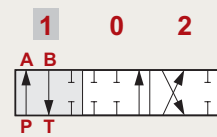

P & T & A & B closed
 C open

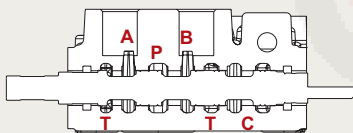
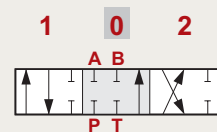

P → B
 A → T
 C closed

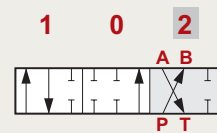

Type 8ESN#2

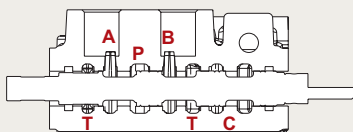

P → A
 B → T
 C closed

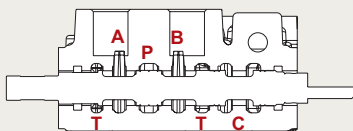
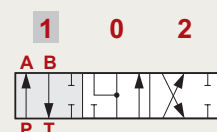

A & B → T
 P closed
 C open

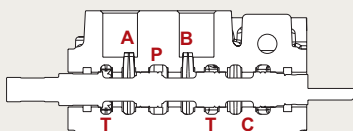
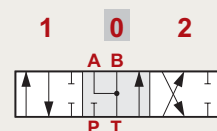

P → B
 A → T
 C closed

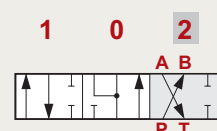

MB-3 Service and auxiliary valves

Monoblock Directional Control Valves

Type P

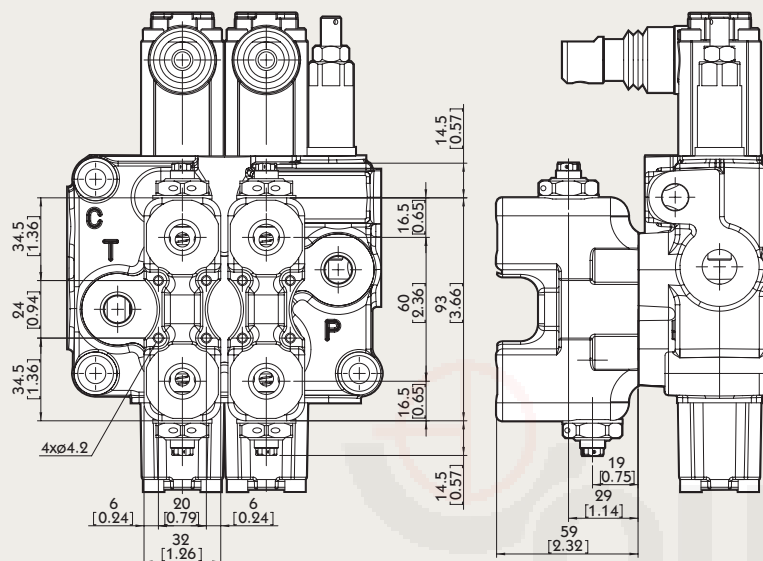

P1 Kit: Block with valve on port A

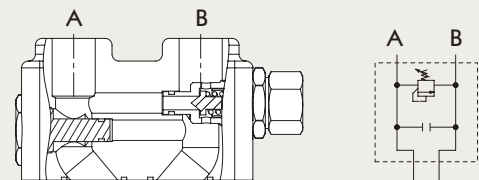

P2 Kit: Block with valve on port B

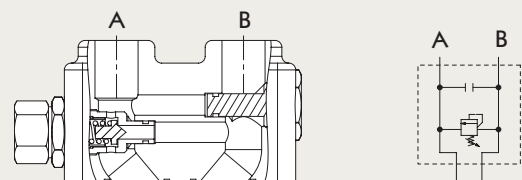

P3 Kit: Block with valve on port A and B

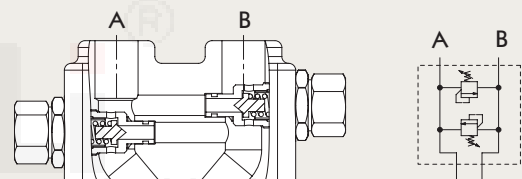

Type BPS Pilot check valves (With Pre-opening, supplied with mounting block)

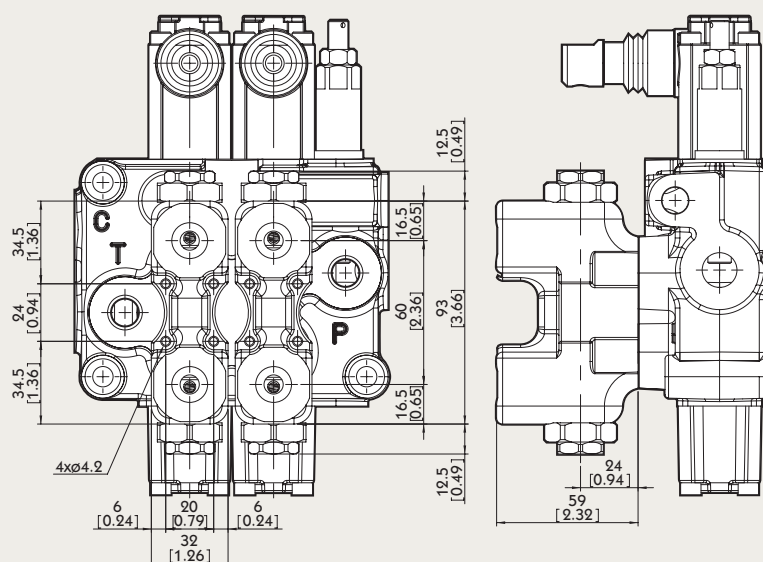

BPS1 Kit: Block with valve on port A

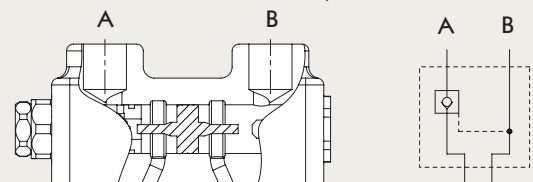

BPS2 Kit: Block with valve on port B

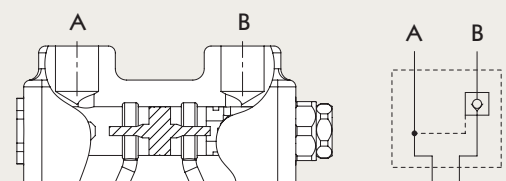

BPS3 Kit: Block with valve on port A and B

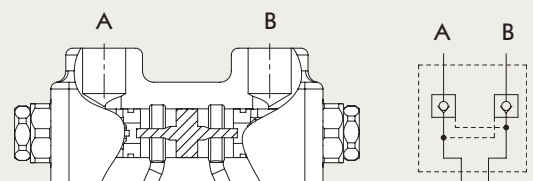

MB-3 Accessories

Monoblock Directional Control Valves

Type JHP-2

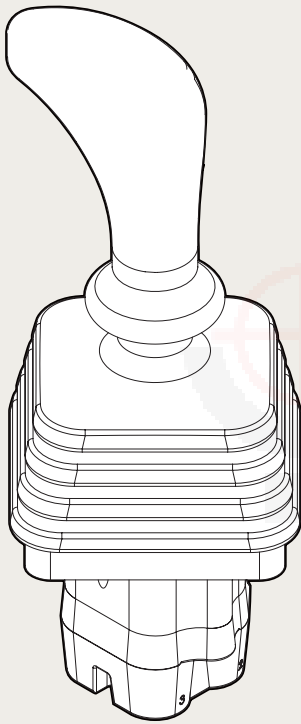

Specifications:

- This data sheet shows technical spec. with mineral oil of 46 mm²/s (cSt) viscosity at 40 °C (104 °F)
- Flow : 5 ~ 20 LPM
- Feeding pressure : 30 ~ 100 bar
- Max. backpressure : 3 bar
- Internal leakage at 30 bar : 10 ~ 18 cm³/min
- Fluid : mineral oil
- Fluid temperature : - 10 ~ 80 °C
- Ambient temperature : - 40 ~ 60 °C

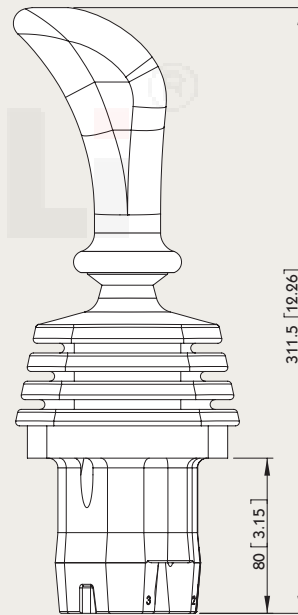

HYDRAULIC SCHEME:

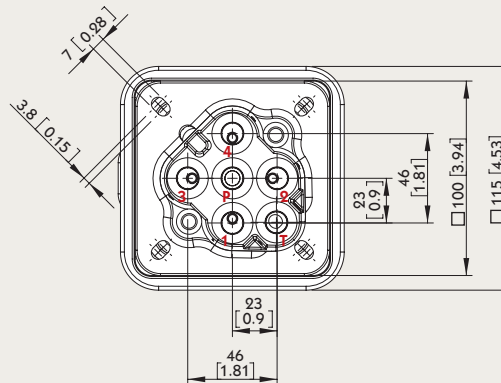
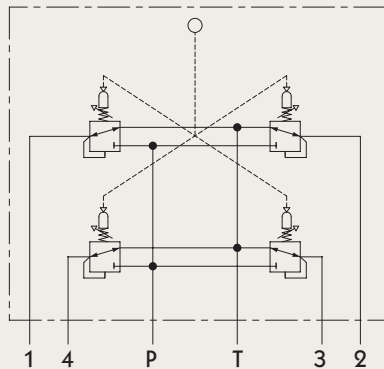

MB-3 Accessories

Monoblock Directional Control Valves

Type PHP-1

Specifications:

- This data sheet shows technical spec. with mineral oil of 46 mm²/s (cSt) viscosity at 40 °C (104 °F)
- Flow : 5 ~ 20 LPM
- Feeding pressure : 30 ~ 100 bar
- Max. backpressure : 3 bar
- Internal leakage at 30 bar : 10 ~ 18 cm³/min
- Fluid : mineral oil
- Fluid temperature : - 10 ~ 80 °C
- Ambient temperature : - 40 ~ 60 °C

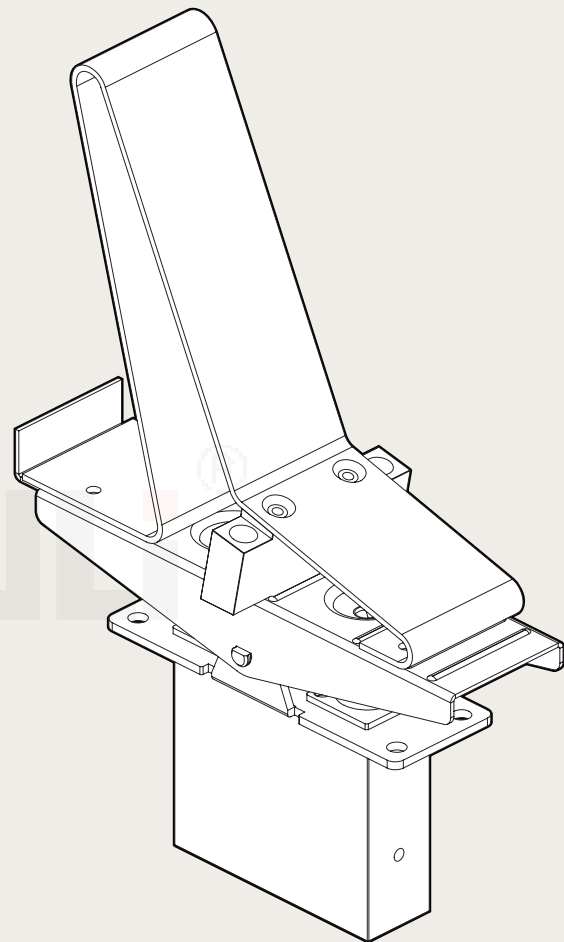
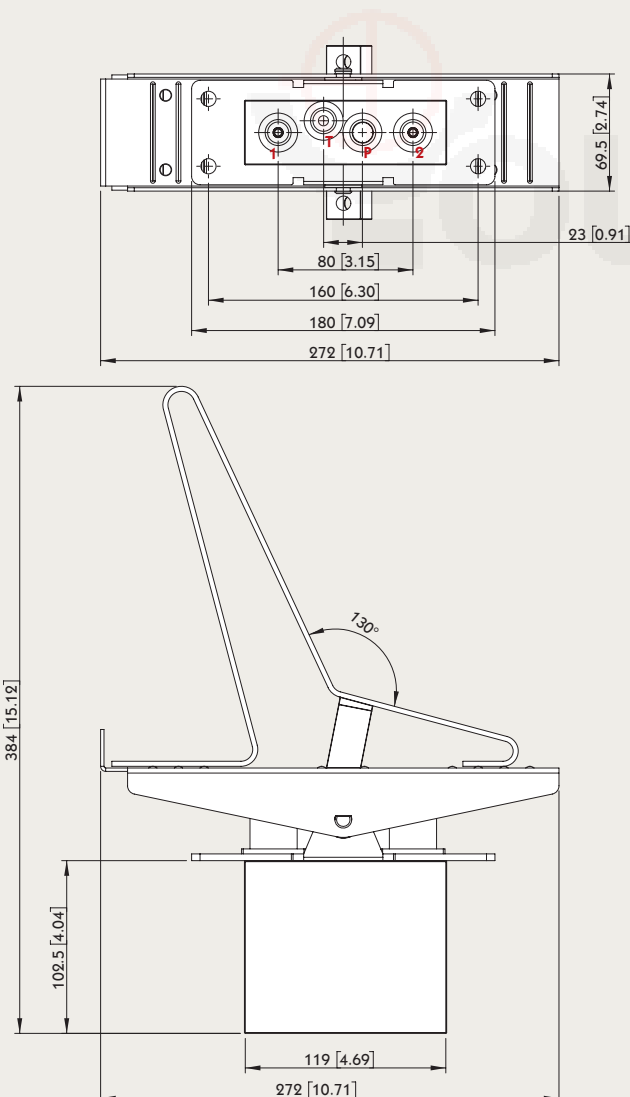

HYDRAULIC SCHEME:

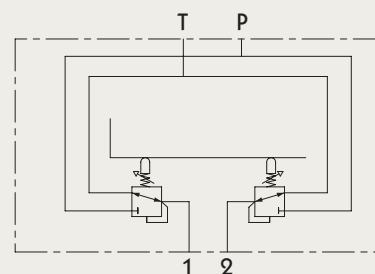

MB-3 Outlet

Monoblock Directional Control Valves

Power Beyond Conversion plug
(Closed center plug)

